

RQA0009SXAQS

R07DS0493EJ0200
 (Previous: REJ03G1566-0100)
 Rev.2.00
 Jun 28, 2011

Silicon N-Channel MOS FET

Features

- High Output Power, High Gain, High Efficiency
 $P_{out} = +37.8 \text{ dBm}$, Linear Gain = 18 dB, PAE = 65%
 $(V_{DS} = 6 \text{ V}, f = 520 \text{ MHz})$
- Compact package capable of surface mounting
- Electrostatic Discharge Immunity Test
 (IEC Standard, 61000-4-2, Level4)

Outline

RENESAS Package code: PLZZ0004CA-A
 (Package Name : UPAK)

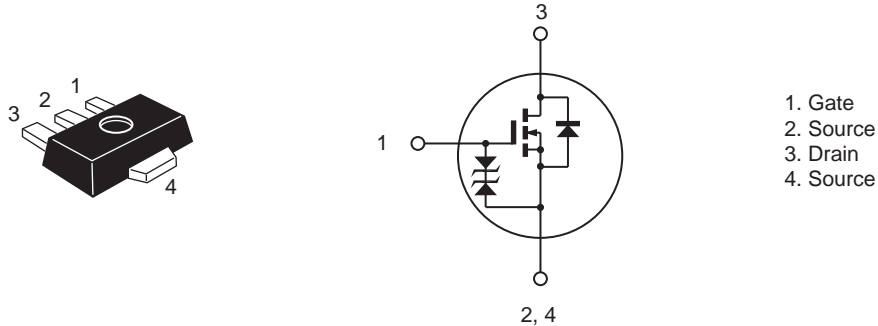

Note: Marking is "SX".

Absolute Maximum Ratings

($T_a = 25^\circ\text{C}$)

Item	Symbol	Ratings	Unit
Drain to source voltage	V_{DSS}	16	V
Gate to source voltage	V_{GSS}	± 5	V
Drain current	I_D	3.2	A
Channel dissipation	P_{ch}^{note}	15	W
Channel temperature	T_{ch}	150	$^\circ\text{C}$
Storage temperature	T_{stg}	-55 to +150	$^\circ\text{C}$

Note: Value at $T_c = 25^\circ\text{C}$

This device is sensitive to electro static discharge. An adequate careful handling procedure is requested.

Electrical Characteristics

(Ta = 25°C)

Item	Symbol	Min.	Typ	Max.	Unit	Test Conditions
Zero gate voltage drain current	I_{DSS}	—	—	15	μA	$V_{DS} = 16\text{ V}, V_{GS} = 0$
Gate to source leak current	I_{GSS}	—	—	± 2	μA	$V_{GS} = \pm 5\text{ V}, V_{DS} = 0$
Gate to source cutoff voltage	$V_{GS(off)}$	0.15	0.5	0.8	V	$V_{DS} = 6\text{ V}, I_D = 1\text{ mA}$
Forward Transfer Admittance	$ y_{fs} $	—	3.2	—	S	$V_{DS} = 6\text{ V}, I_D = 1.6\text{ A}$
Input capacitance	C_{iss}	—	76	—	pF	$V_{GS} = 5\text{ V}, V_{DS} = 0, f = 1\text{ MHz}$
Output capacitance	C_{oss}	—	40	—	pF	$V_{DS} = 6\text{ V}, V_{GS} = 0, f = 1\text{ MHz}$
Reverse transfer capacitance	C_{rss}	—	3.5	—	pF	$V_{DG} = 6\text{ V}, V_{GS} = 0, f = 1\text{ MHz}$
Output Power	Pout	—	33.1	—	dBm	$V_{DS} = 3.6\text{ V}, I_{DQ} = 200\text{ mA}$ $f = 155\text{ MHz},$ Pin = +20 dBm (100 mW)
		—	2.0	—	W	
Power Added Efficiency	PAE	—	65.7	—	%	
Output Power	Pout	—	38.6	—	dBm	$V_{DS} = 7.0\text{ V}, I_{DQ} = 200\text{ mA}$ $f = 155\text{ MHz},$ Pin = +25 dBm (316 mW)
		—	7.2	—	W	
Power Added Efficiency	PAE	—	62.5	—	%	
Output Power	Pout	—	33.0	—	dBm	$V_{DS} = 3.6\text{ V}, I_{DQ} = 200\text{ mA}$ $f = 360\text{ MHz},$ Pin = +20 dBm (100 mW)
		—	2.0	—	W	
Power Added Efficiency	PAE	—	68.5	—	%	
Output Power	Pout	—	38.8	—	dBm	$V_{DS} = 7.0\text{ V}, I_{DQ} = 200\text{ mA}$ $f = 360\text{ MHz},$ Pin = +25 dBm (316 mW)
		—	7.6	—	W	
Power Added Efficiency	PAE	—	69.2	—	%	
Output Power	Pout	—	33.1	—	dBm	$V_{DS} = 3.6\text{ V}, I_{DQ} = 200\text{ mA}$ $f = 465\text{ MHz},$ Pin = +20 dBm (100 mW)
		—	2.1	—	W	
Power Added Efficiency	PAE	—	66.4	—	%	
Output Power	Pout	—	39.0	—	dBm	$V_{DS} = 7.0\text{ V}, I_{DQ} = 200\text{ mA}$ $f = 465\text{ MHz},$ Pin = +25 dBm (316 mW)
		—	8.0	—	W	
Power Added Efficiency	PAE	—	67.9	—	%	
Output Power	Pout	—	35.2	—	dBm	$V_{DS} = 4.8\text{ V}, I_{DQ} = 300\text{ mA}$ $f = 465\text{ MHz},$ Pin = +17 dBm (50 mW)
		—	3.3	—	W	
Power Added Efficiency	PAE	—	60	—	%	
Output Power	Pout	—	37.8	—	dBm	$V_{DS} = 6\text{ V}, I_{DQ} = 180\text{ mA}$ $f = 520\text{ MHz},$ Pin = +25 dBm (316 mW)
		—	6.0	—	W	
Power Added Efficiency	PAE	—	65	—	%	

Main Characteristics

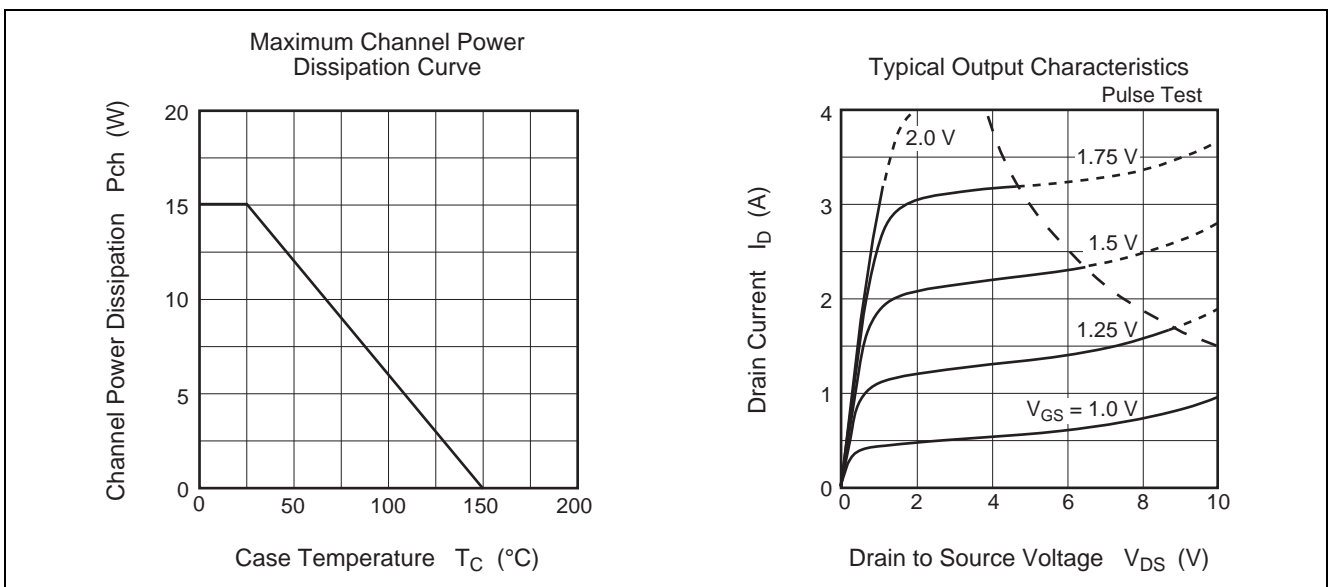

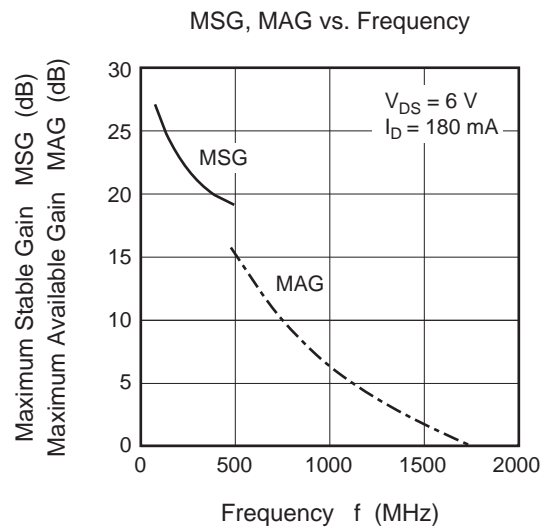
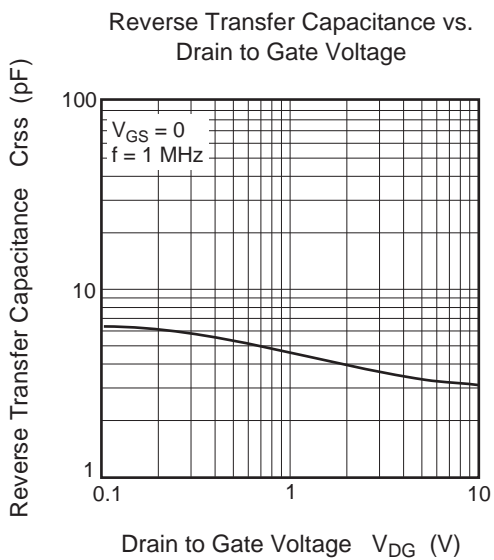
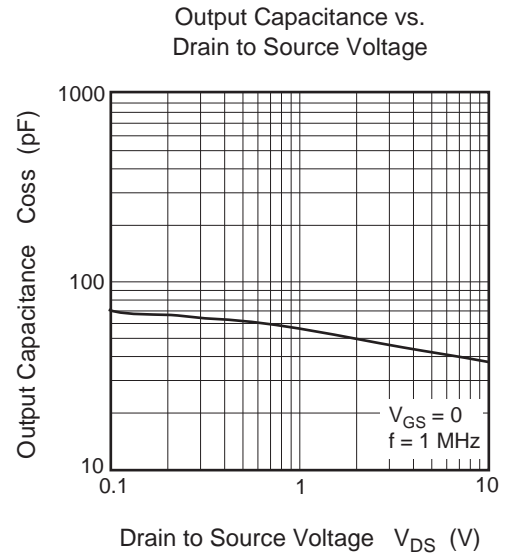
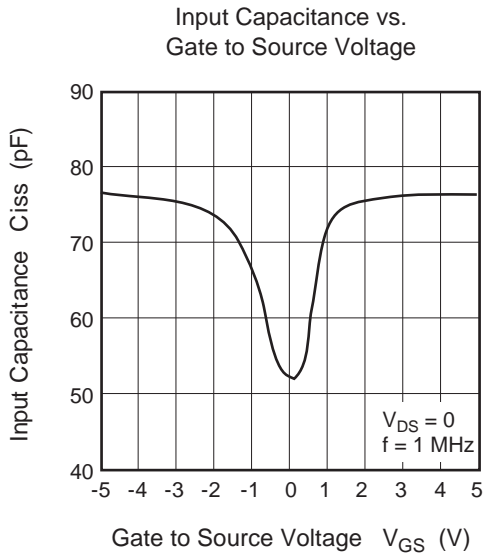
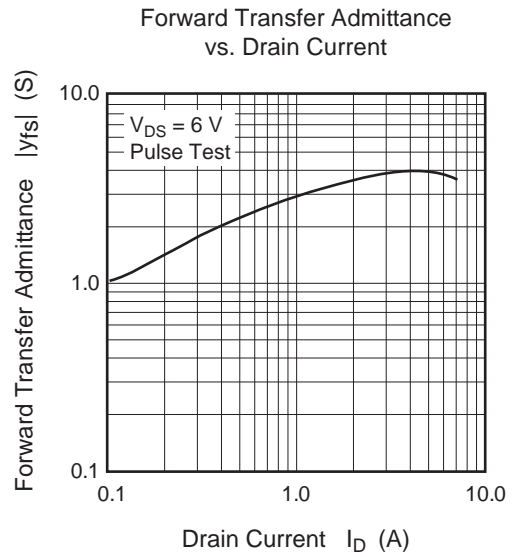
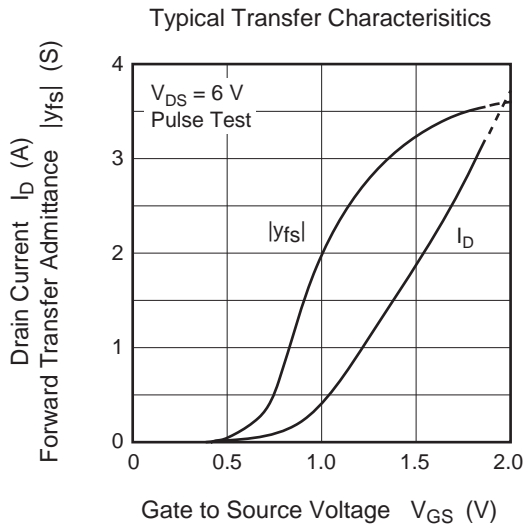

Evaluation Circuit 1 (@V_{DD} = 3.6 & 7.0V Tuning, f = 155 MHz)

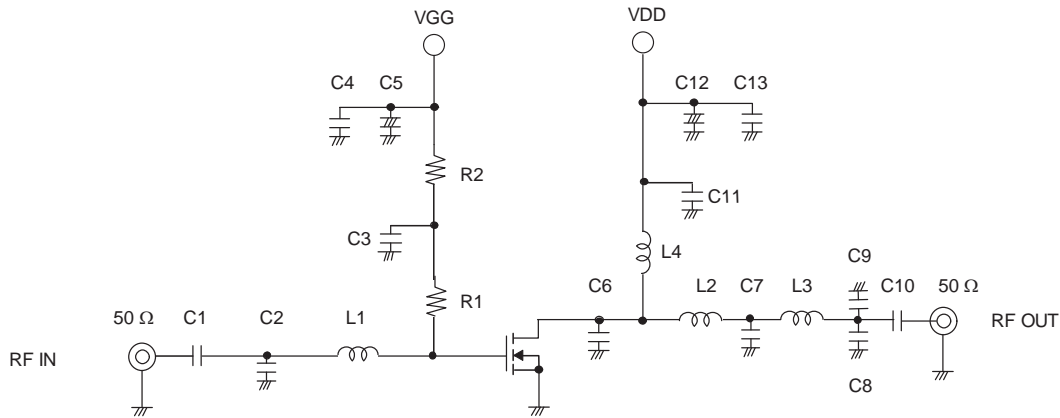

- | | | | |
|------------------|-----------------------------------|----|---|
| C1, C3, C10, C11 | 100 pF Chip Capacitor | L1 | 33 nH Chip Inductor |
| C2 | 27 pF Chip Capacitor | L2 | 3.6 nH Chip Inductor |
| C4, C13 | 1000 pF Chip Capacitor | L3 | 7.5 nH Chip Inductor |
| C5, C12 | 1 μF/+16V Chip Tantalum Capacitor | L4 | 8 Turns D: 0.5 mm, φ 2.4 mm Enamel Wire |
| C6 | 18 pF Chip Capacitor | R1 | 33 Ω Chip Resistor |
| C7 | 22 pF Chip Capacitor | R2 | 1 kΩ Chip Resistor |
| C8 | 56 pF Chip Capacitor | | |
| C9 | 4 pF Chip Capacitor | | |

Output Power, Drain Current vs. Input Power

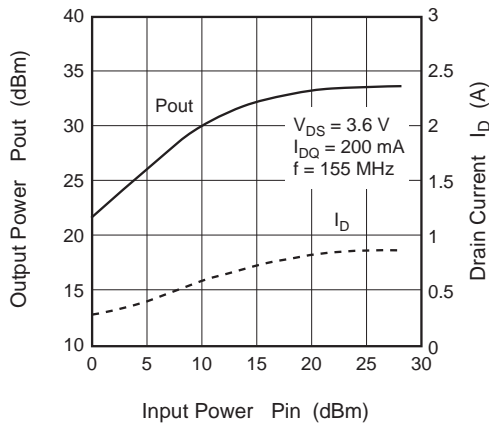

Power Gain, Power Added Efficiency vs. Input Power

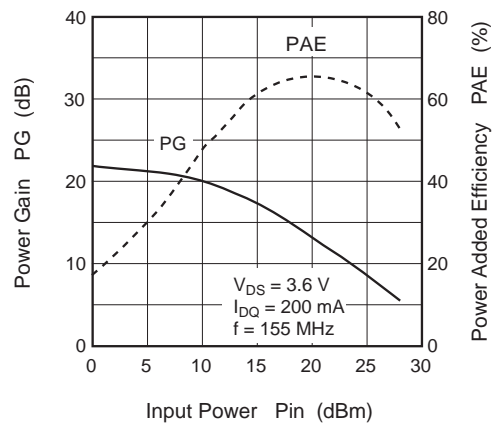

Output Power, Drain Current vs. Frequency

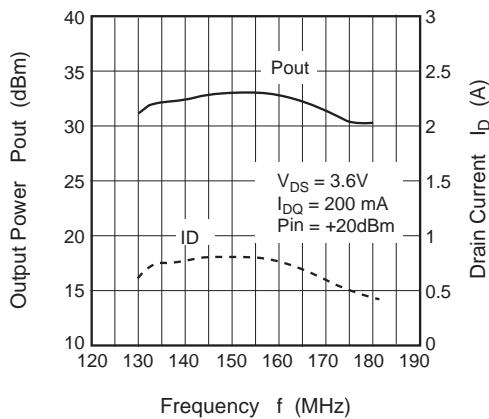

Power Gain, Power Added Efficiency vs. Frequency

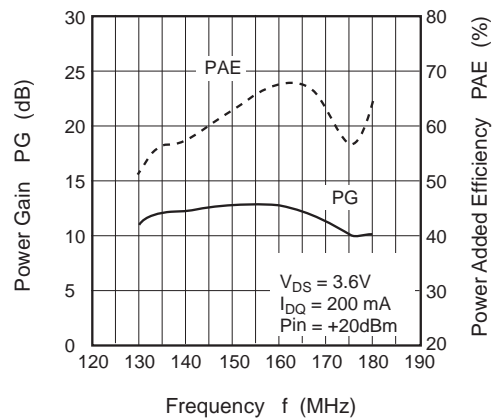

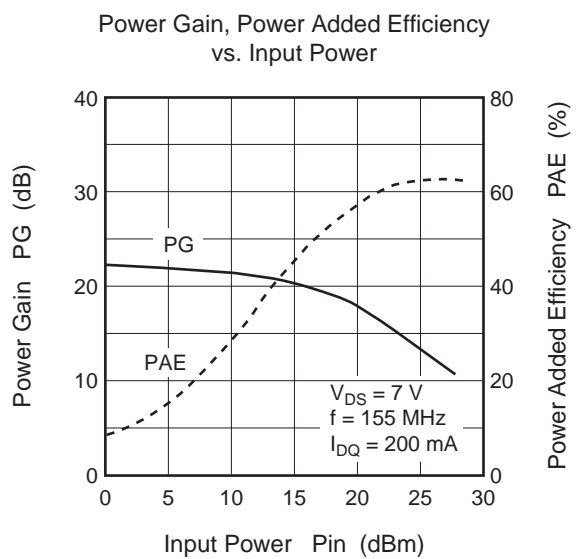
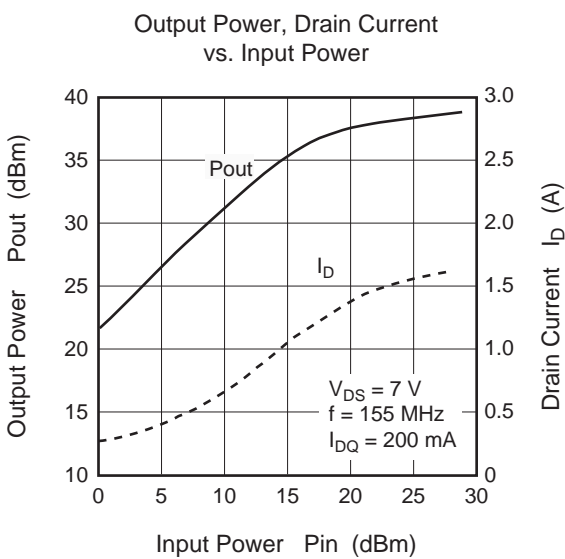
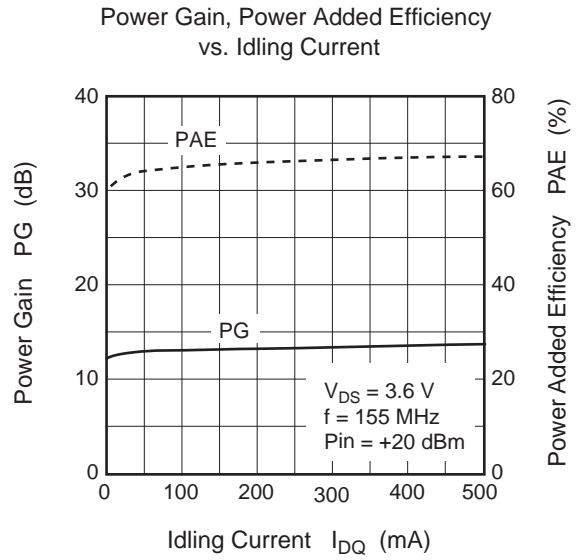
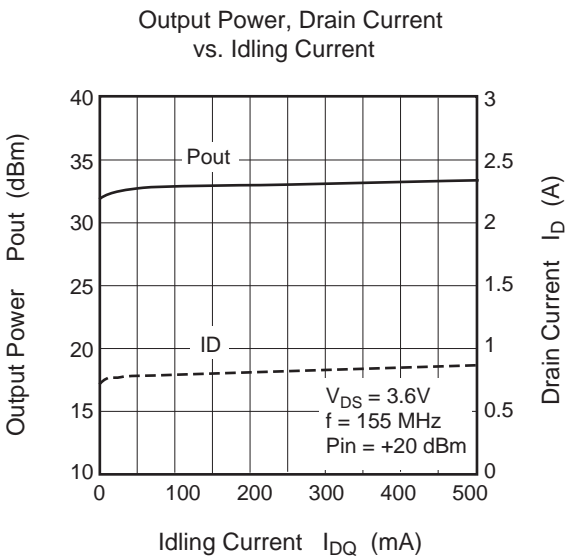
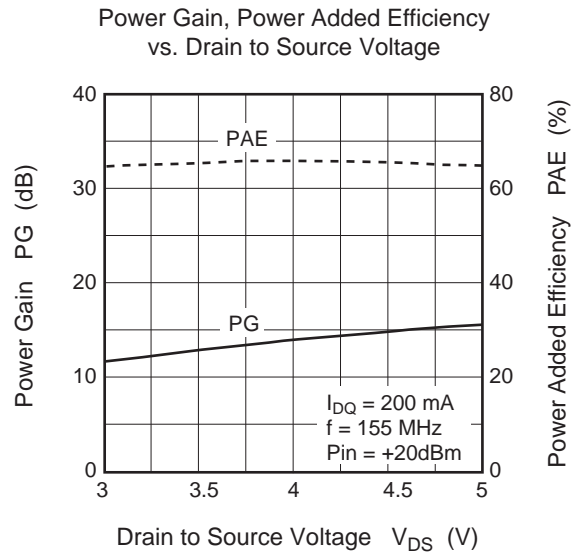
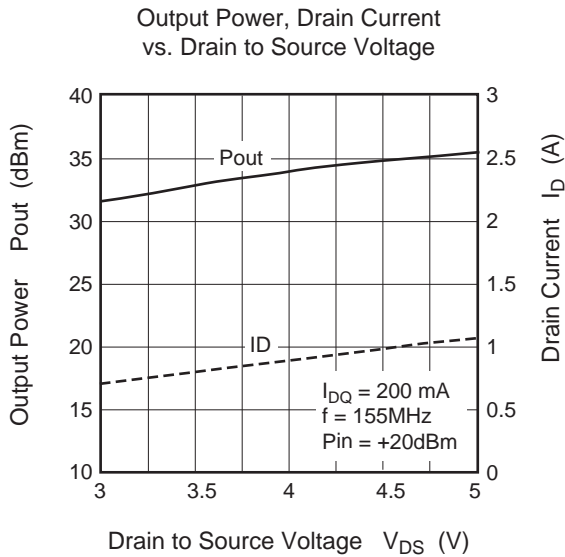

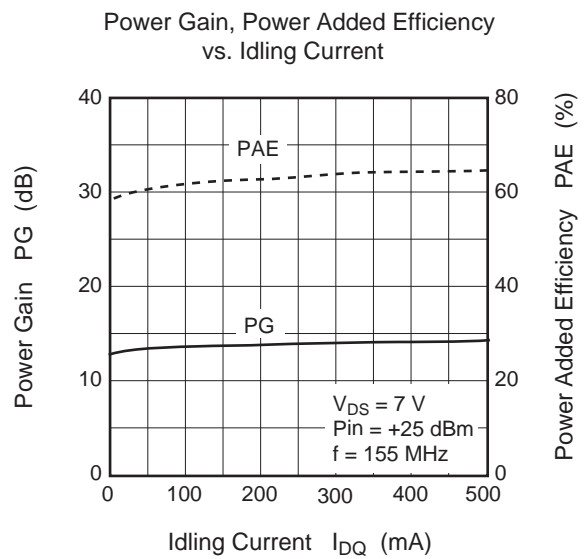
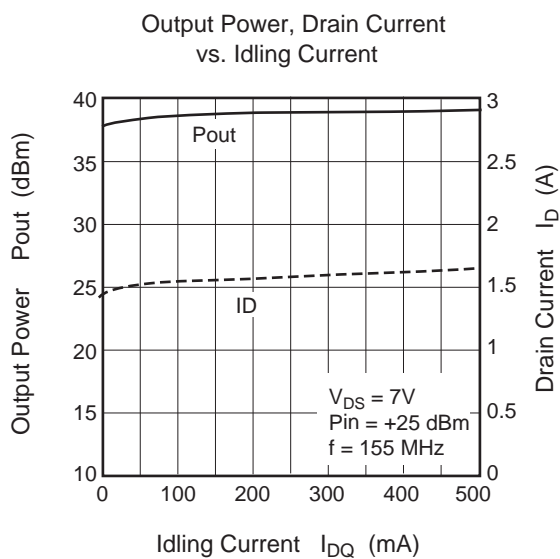
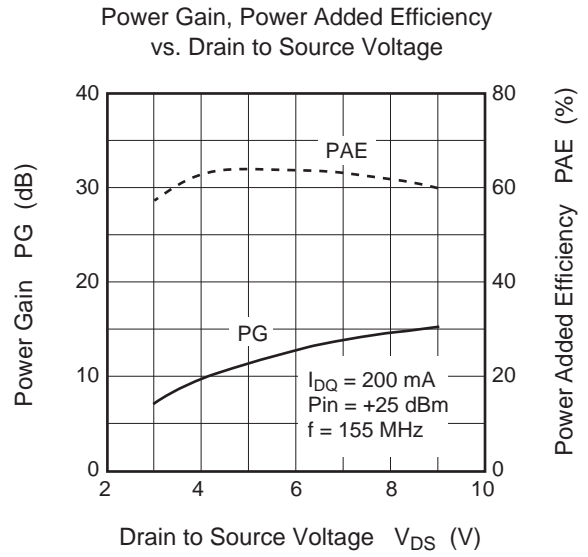
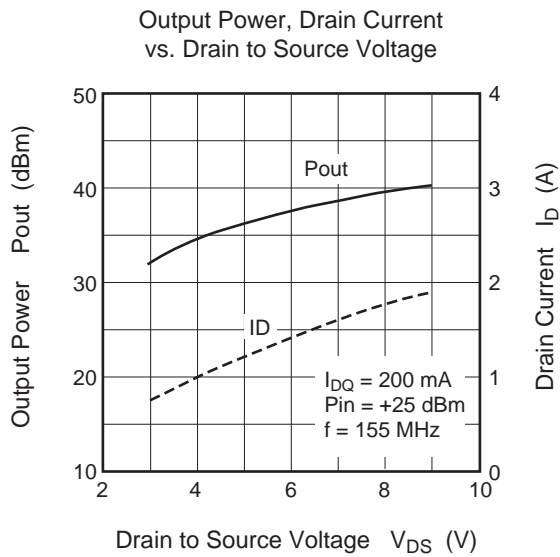
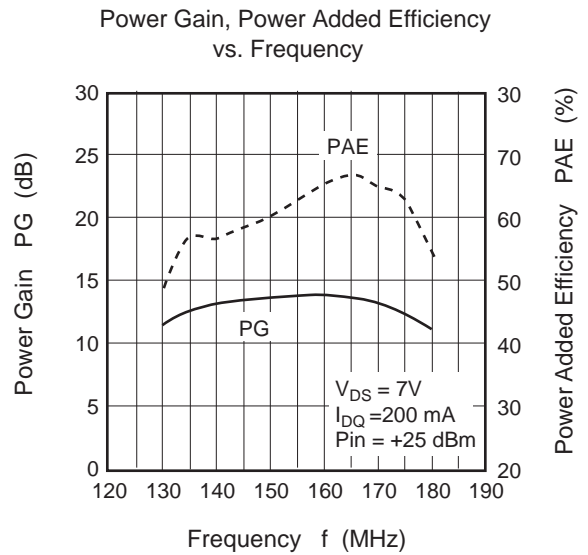
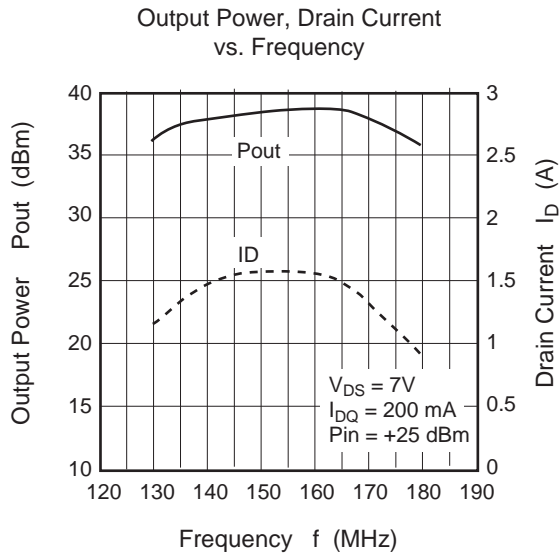

Evaluation Circuit 1 (@V_{DD} = 3.6 & 7.0V Tuning, f = 360 MHz)

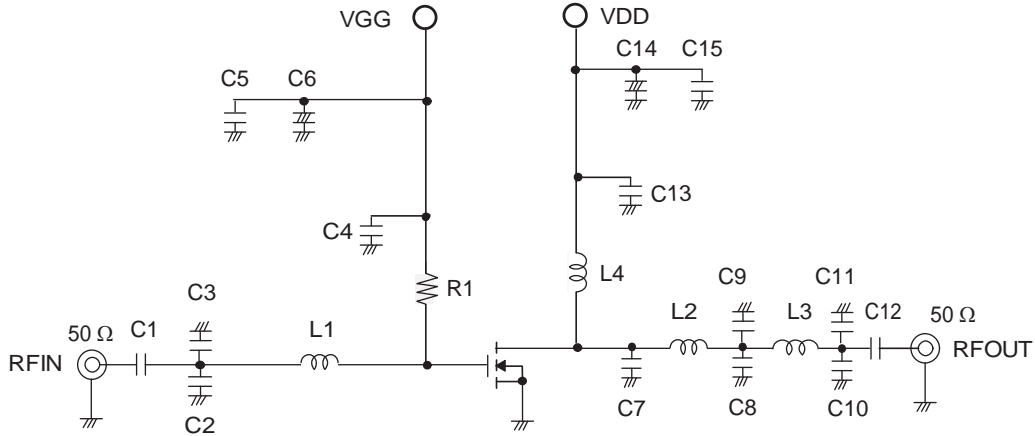

C1	22 pF Chip Capacitor	L1	6.8 nH Chip Inductor
C2, C3, C8, C10	10 pF Chip Capacitor	L2	1.0 nH Chip Inductor
C4, C13	100 pF Chip Capacitor	L3	1.6 nH Chip Inductor
C5, C12, C15	1000 pF Chip Capacitor	L4	8 Turns D: 0.5 mm, φ 2.4 mm Enamel Wire
C6, C14	1 μF / +16V Chip Tantalum Capacitor	R1	6.8k Ω Chip Resistor
C7	5 pF Chip Capacitor		
C9, C11	12 pF Chip Capacitor		

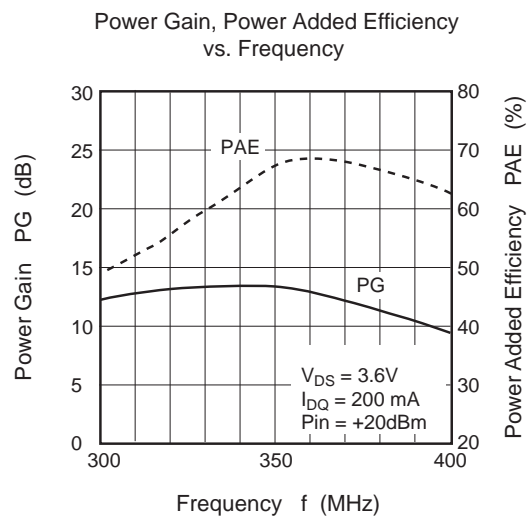
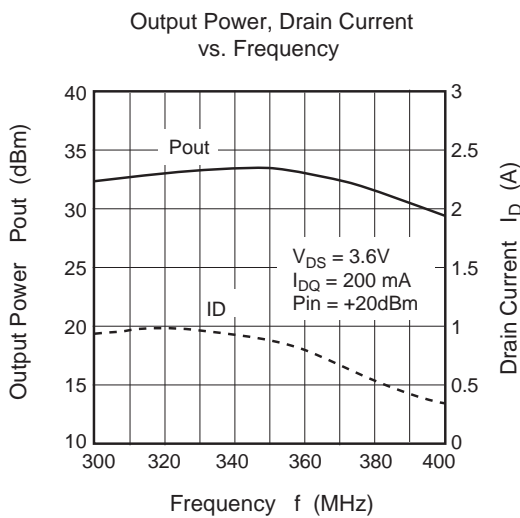
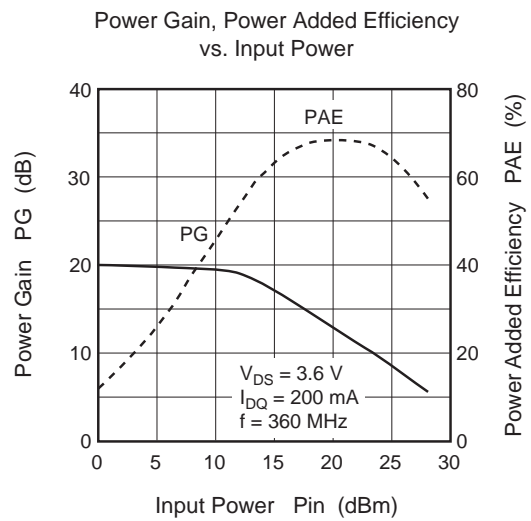
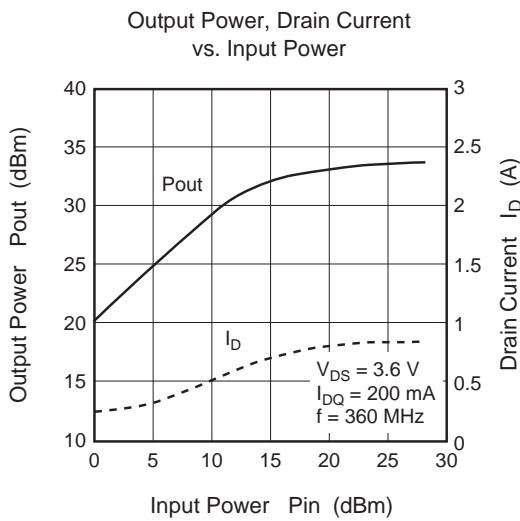

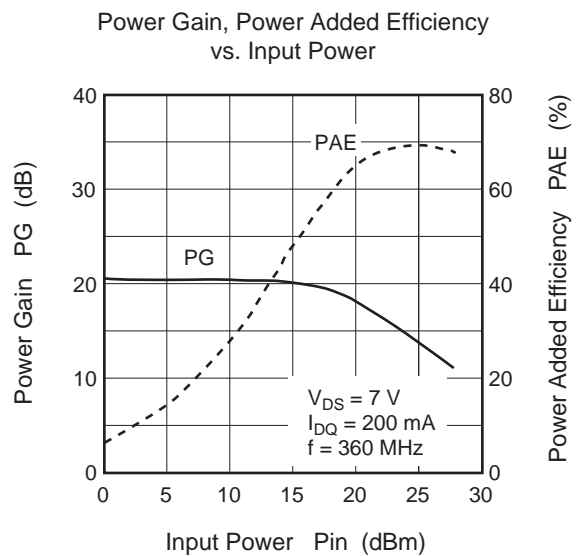
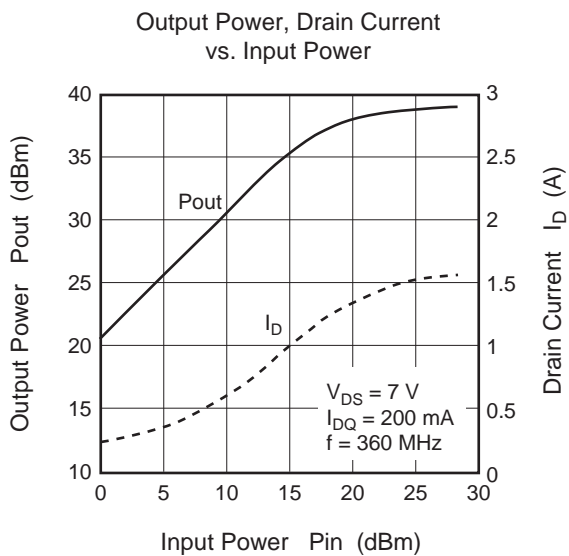
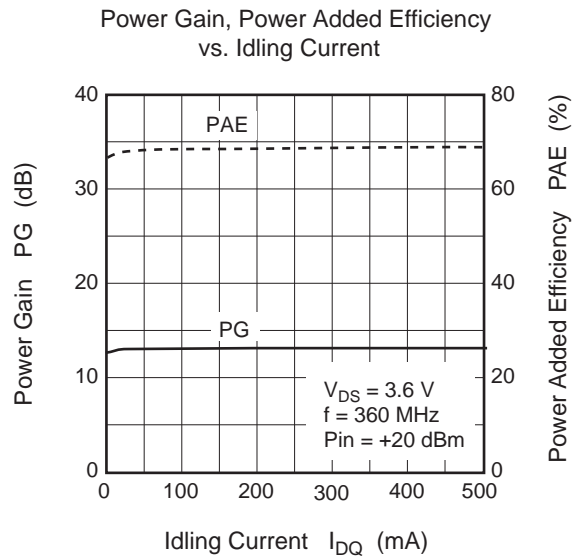
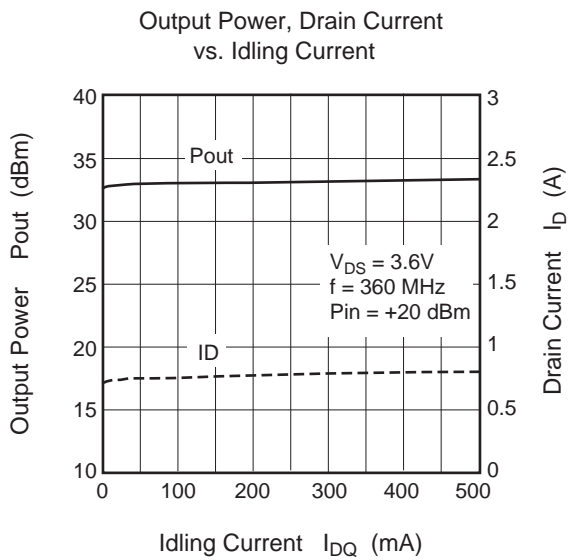
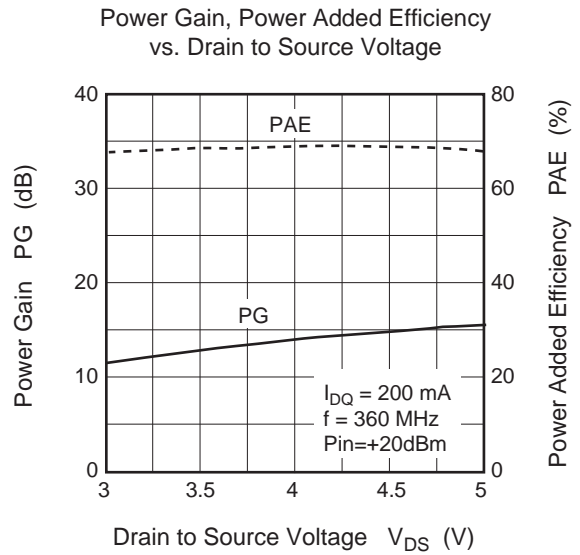
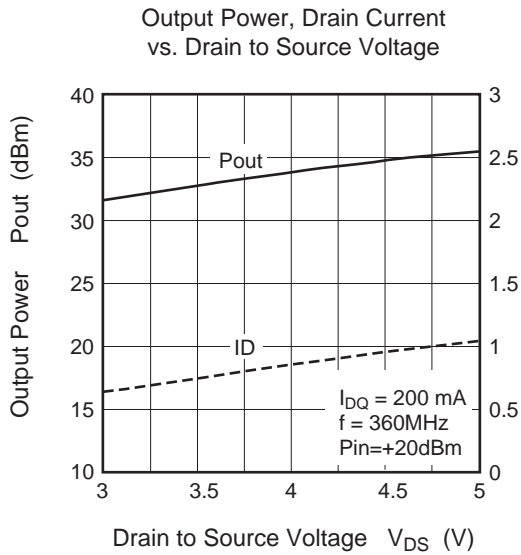

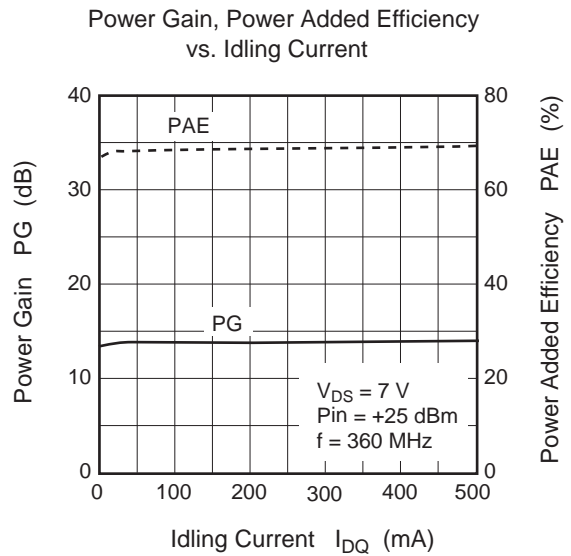
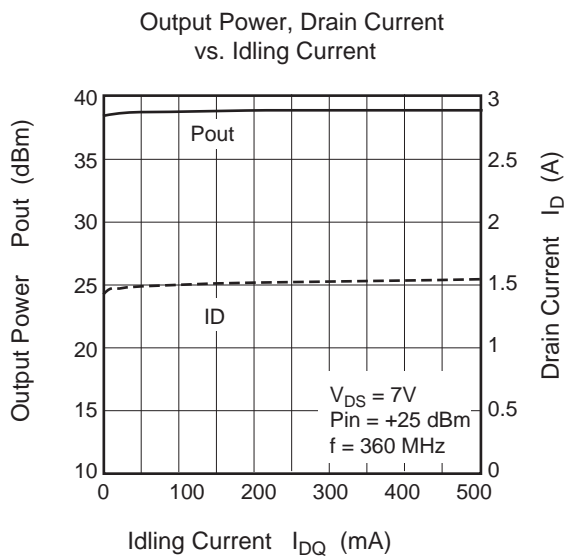
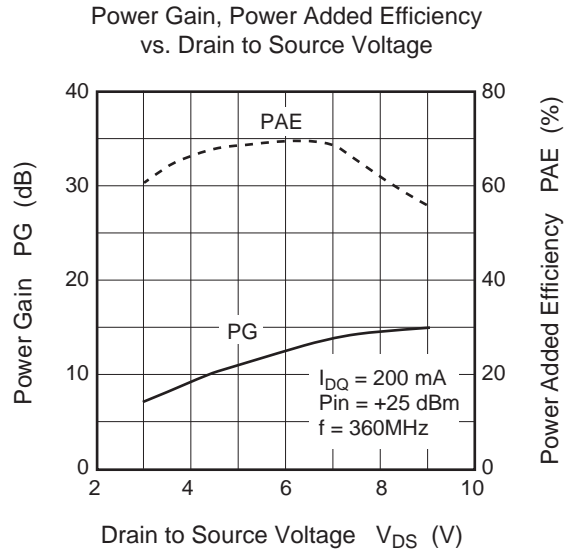
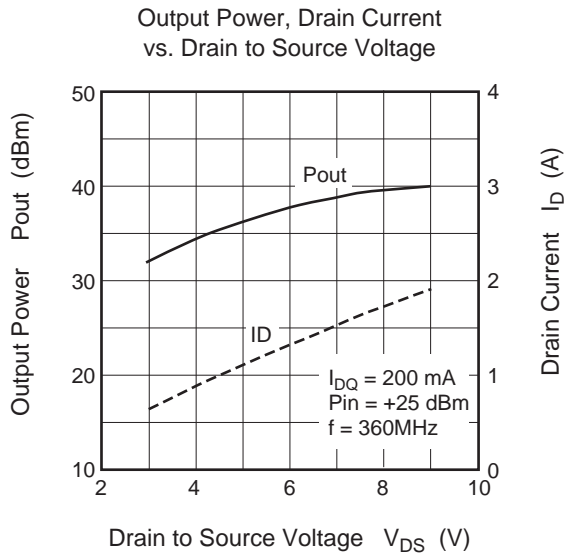
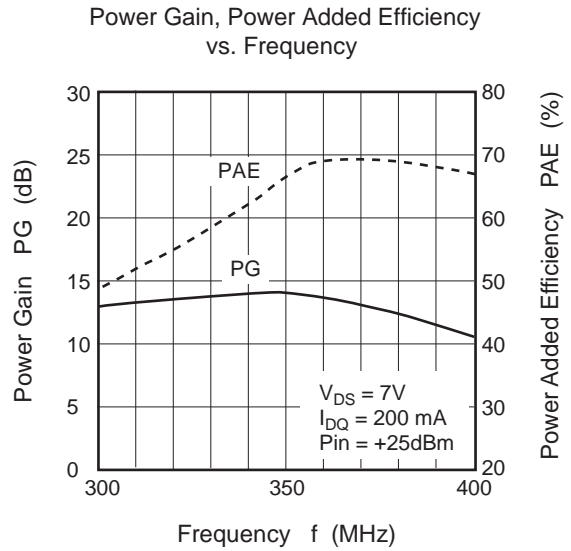
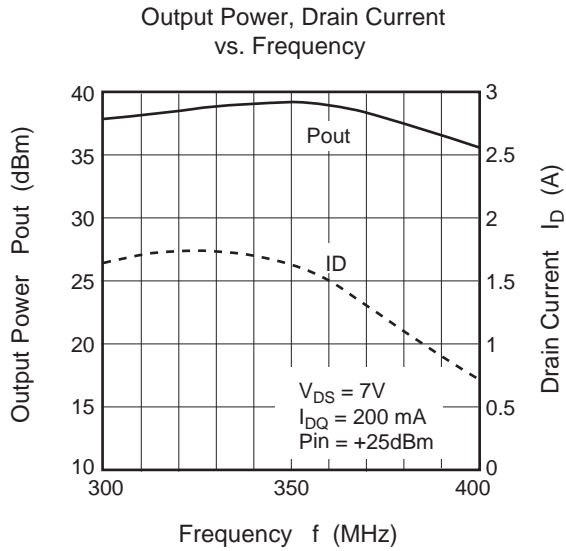

Evaluation Circuit 1 (@V_{DD} = 3.6 & 7.0V Tuning, f = 465 MHz)

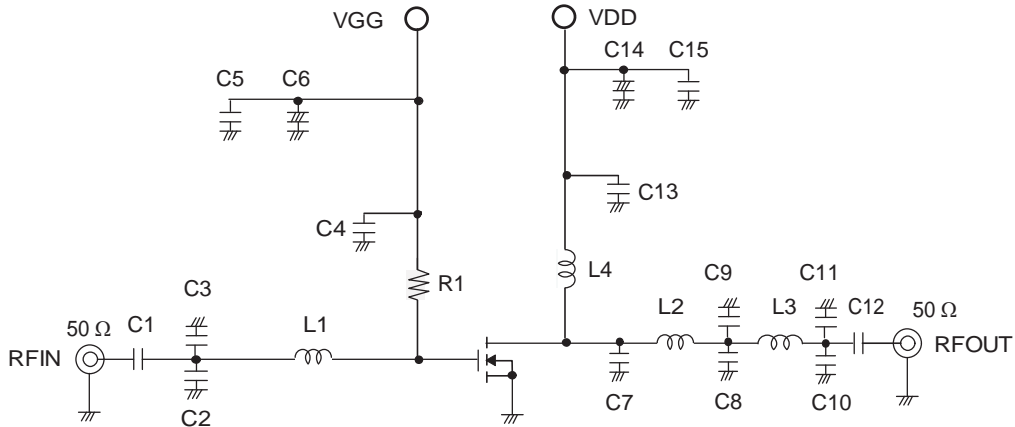

C1	22 pF Chip Capacitor	C9	12 pF Chip Capacitor
C2, C3, C7, C10	10 pF Chip Capacitor	C11	2 pF Chip Capacitor
C4, C13	100 pF Chip Capacitor	L1	2.7 nH Chip Inductor
C5, C12, C15	1000 pF Chip Capacitor	L2, L3	1.0 nH Chip Inductor
C6, C14	1 μF / +16V Chip Tantalum Capacitor	L4	8 Turns D: 0.5 mm, f2.4mm Enamel Wire
C8	7 pF Chip Capacitor	R1	6.8k Ω Chip Resistor

Output Power, Drain Current vs. Input Power

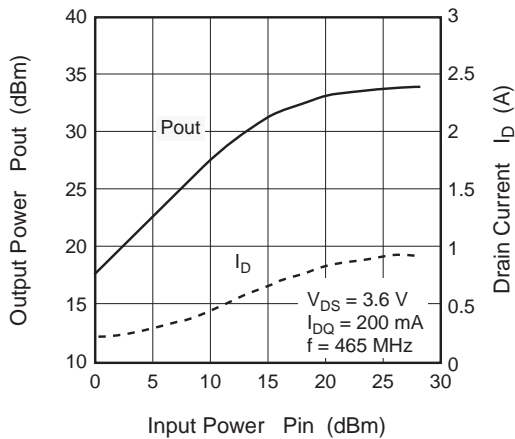

Power Gain, Power Added Efficiency vs. Input Power

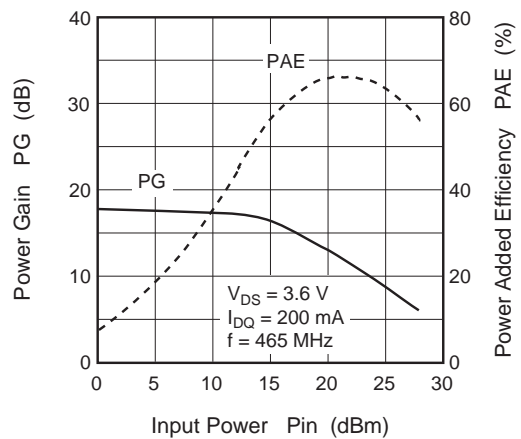

Output Power, Drain Current vs. Frequency

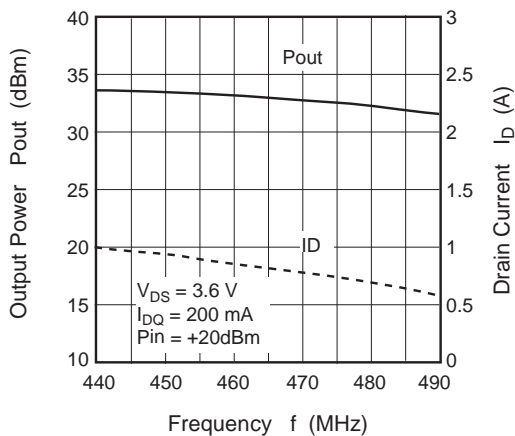

Power Gain, Power Added Efficiency vs. Frequency

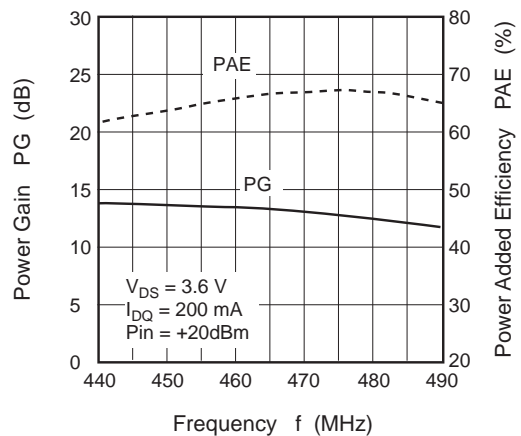

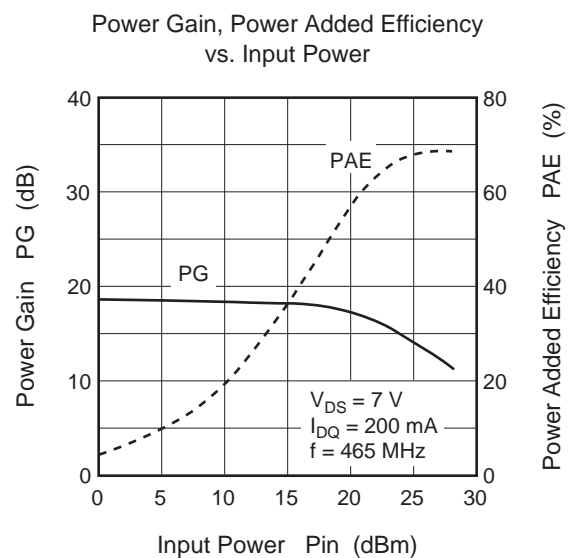
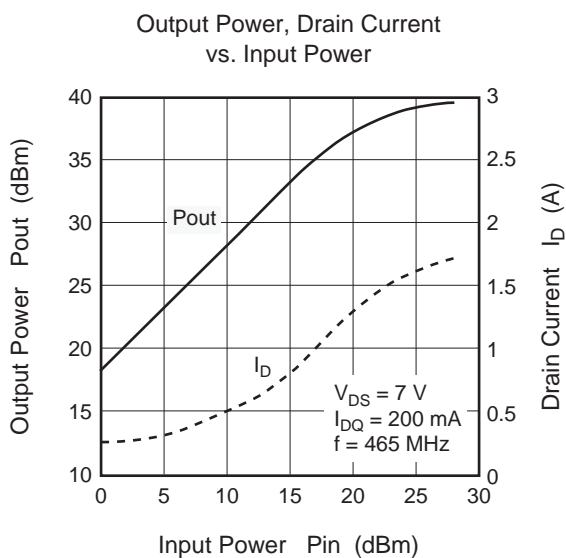
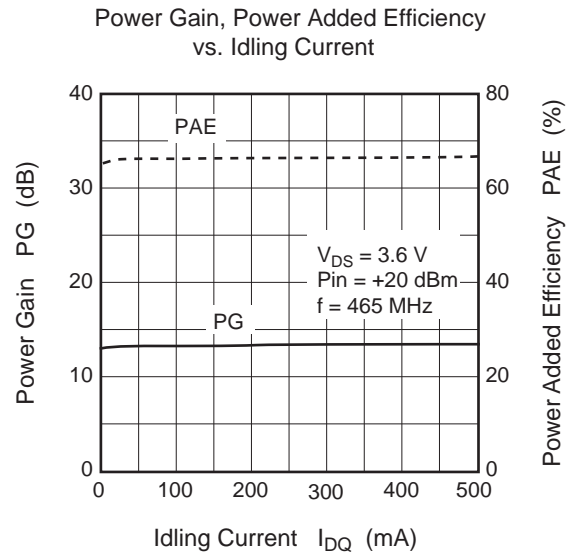
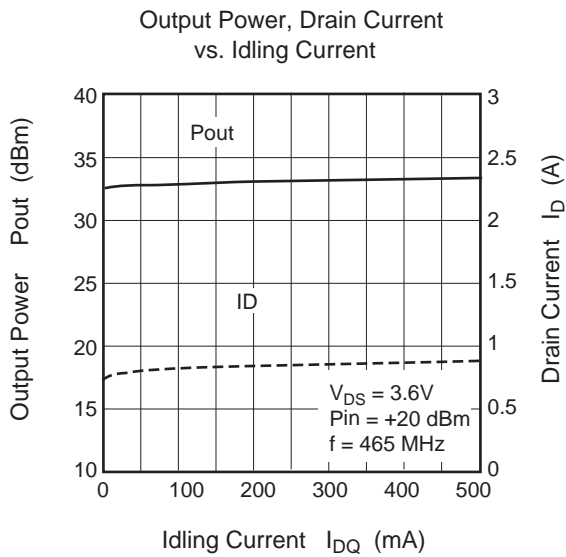
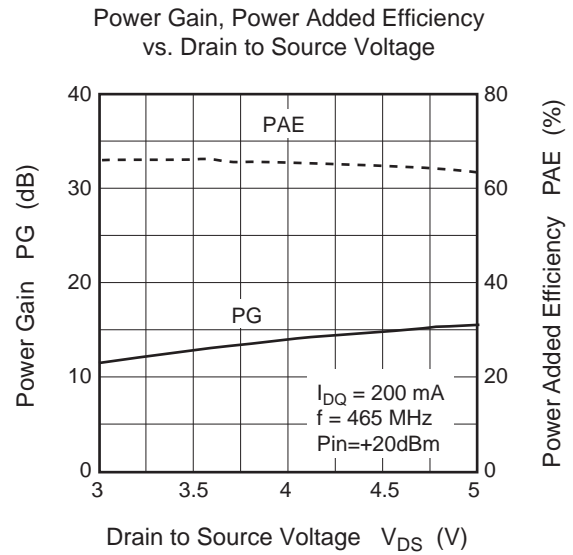
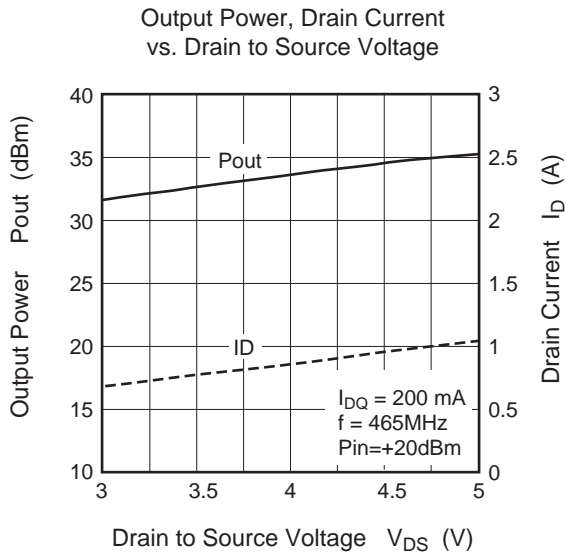

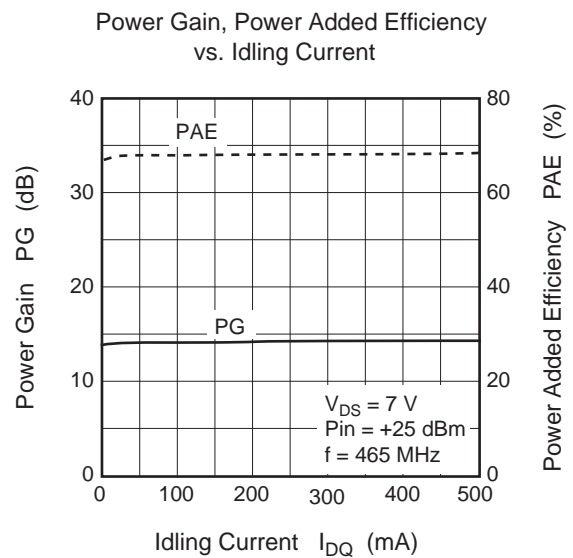
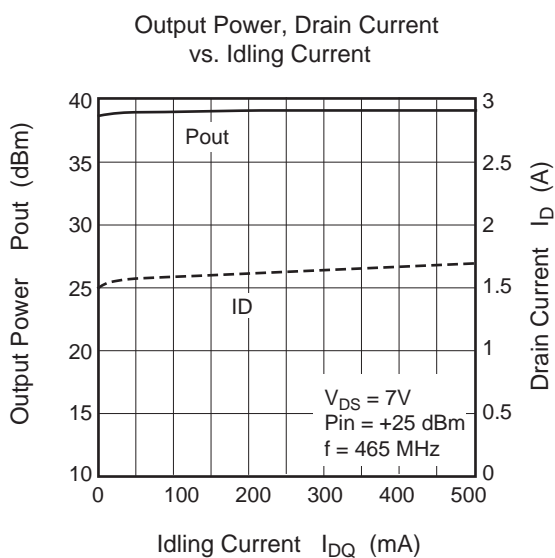
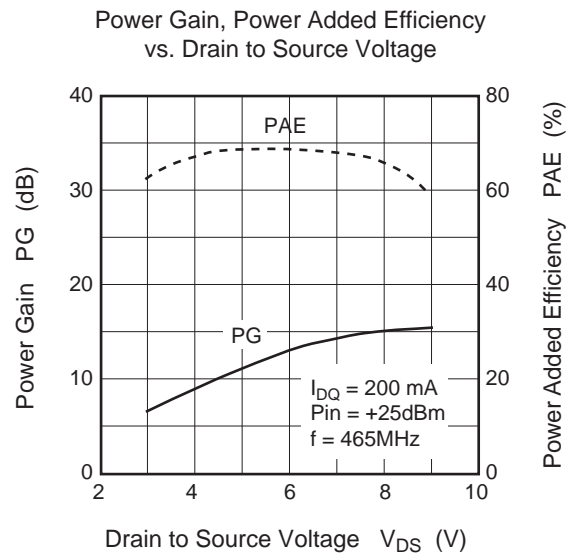
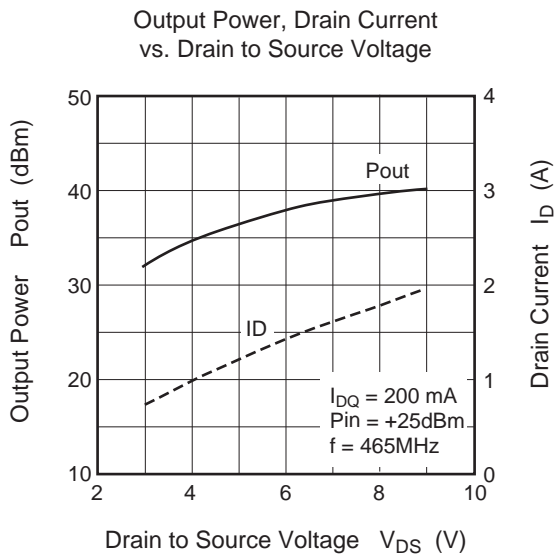
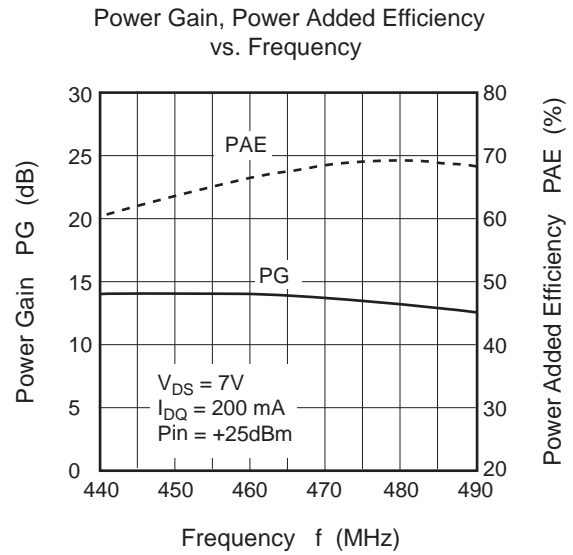
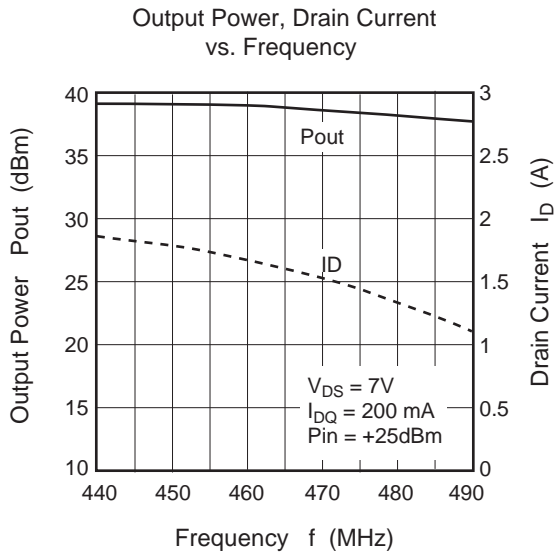

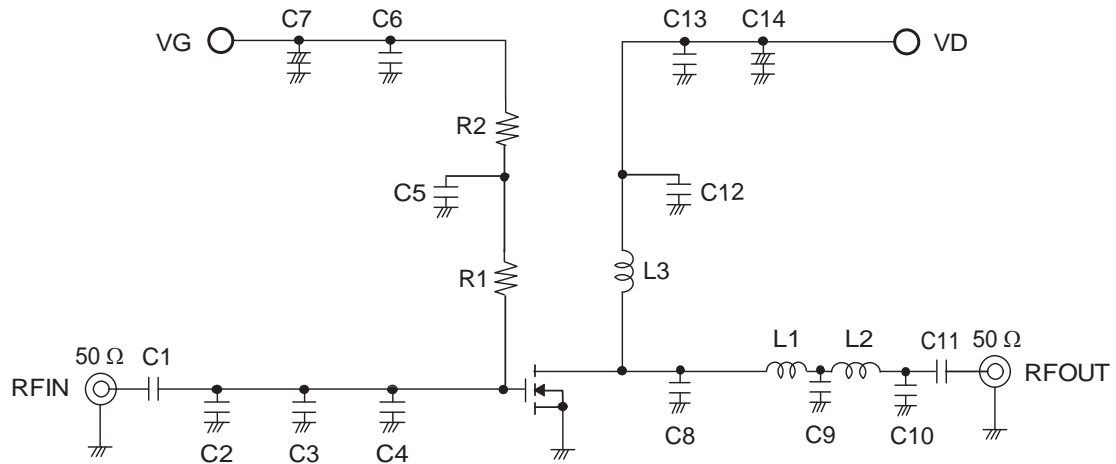
Evaluation Circuit (f = 465 MHz @ V_{DS} = 4.8V)

C1, C5, C11, C12	100 pF Chip Capacitor
C2, C8	22 pF Chip Capacitor
C3	15 pF Chip Capacitor
C4, C9, C10	10 pF Chip Capacitor
C6, C13	2200 pF Chip Capacitor
C7, C14	1 μF / 35 V Chip Tantalum Capacitor
L1	1 nH Chip Inductor
L2	1.8 nH Chip Inductor
L3	8 Turns D: 0.5 mm, φ 2.4 mm Enamel Wire
R1	670 Ω Chip Resistor
R2	6.8 kΩ Chip Resistor

Output Power, Drain Current vs. Input Power

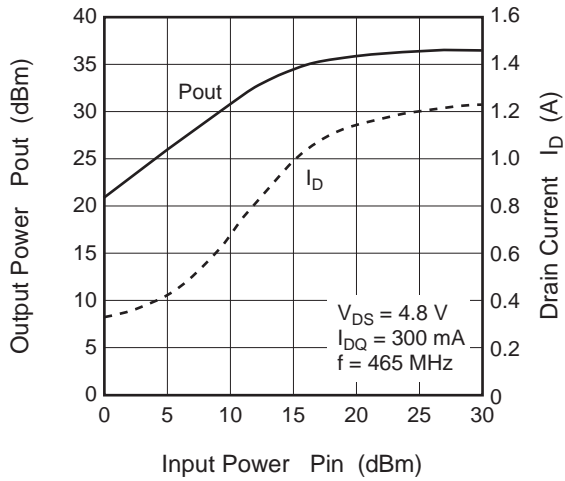

Power Gain, Power Added Efficiency vs. Input Power

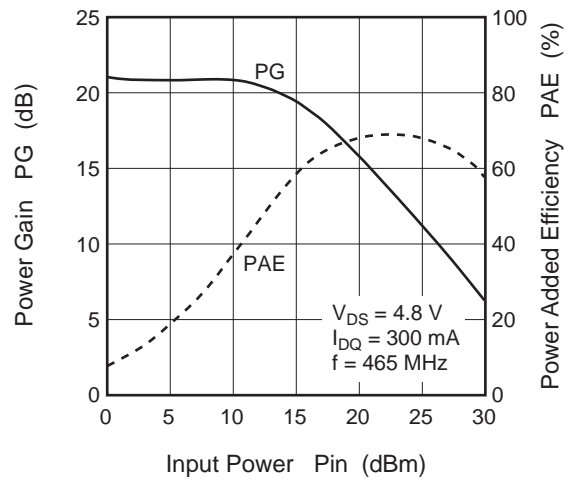

Power Gain, Power Added Efficiency vs. Frequency

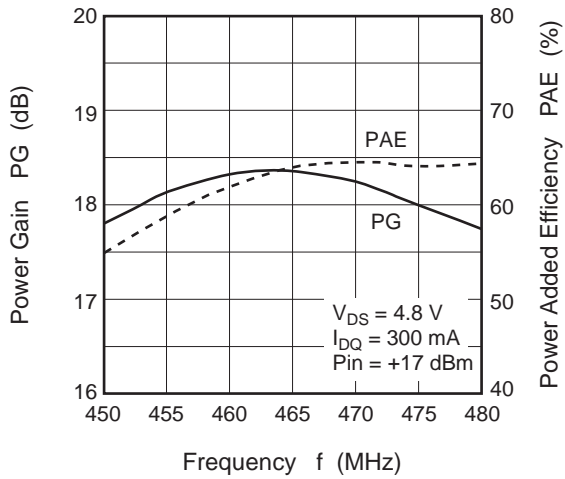

Input Return Loss vs. Frequency

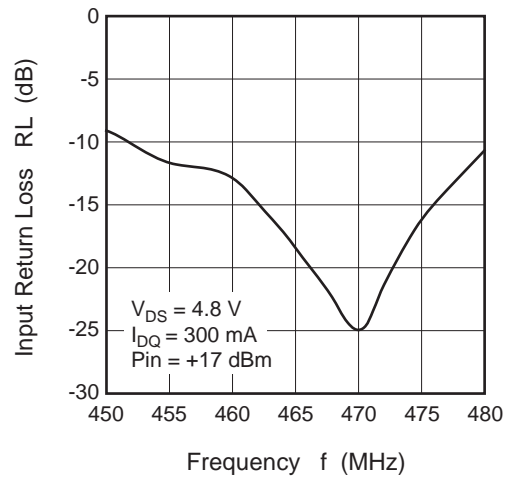

Power Gain, Power Added Efficiency, vs. Drain to Source Voltage

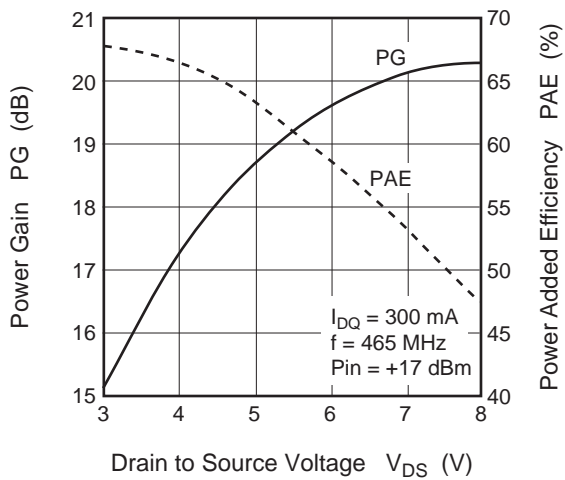

Power Gain, Power Added Efficiency vs. Idling Current

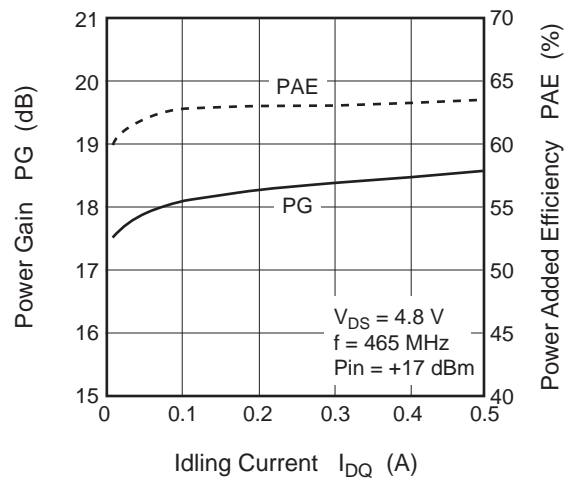

Evaluation Circuit (f = 520 MHz)

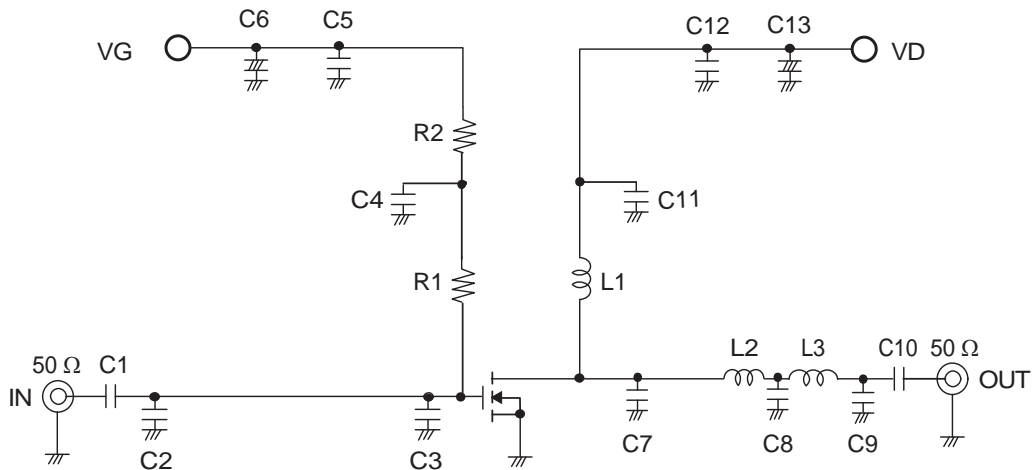

C1, C4, C10, C11	100 pF Chip Capacitor
C2	22 pF Chip Capacitor
C3	5 pF Chip Capacitor
C5, C12	1000 pF Chip Capacitor
C6, C13	1 μ F Chip Tantalum Capacitor
C7	18 pF Chip Capacitor
C8	10 pF Chip Capacitor
C9	7 pF Chip Capacitor
L1	8 Turns D: 0.5 mm, ϕ 2.4 mm Enamel Wire
L2	1 nH Chip Inductor
L3	1.8 nH Chip Inductor
R1	670 Ω Chip Resistor
R2	6.8 k Ω Chip Resistor

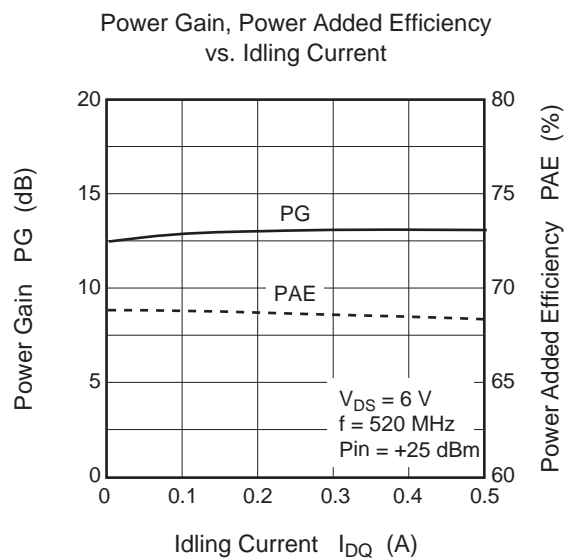
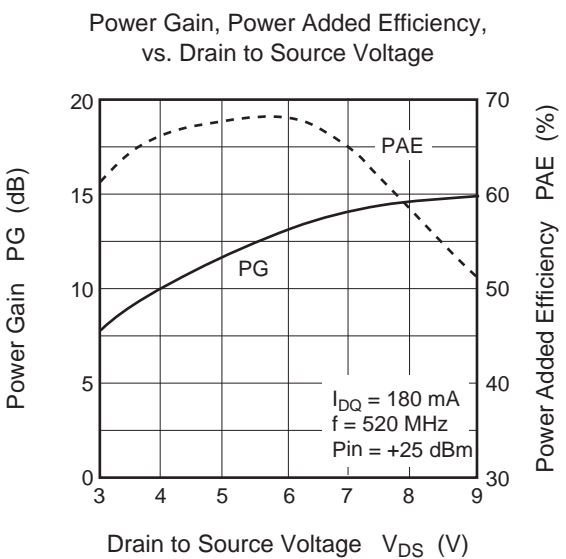
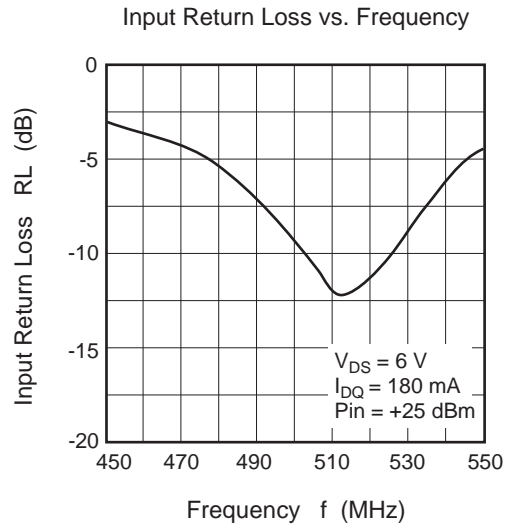
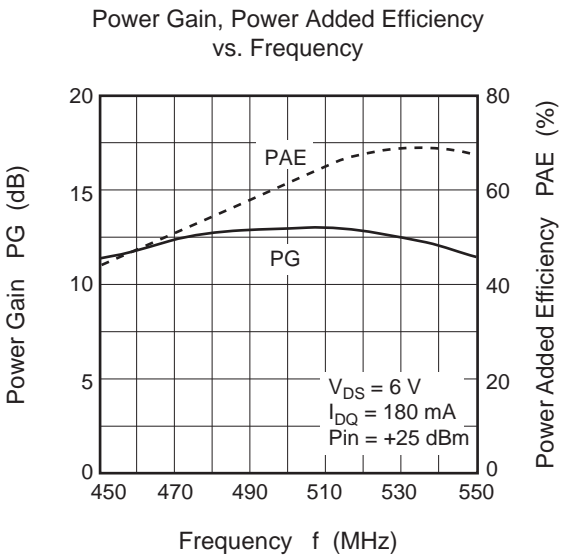
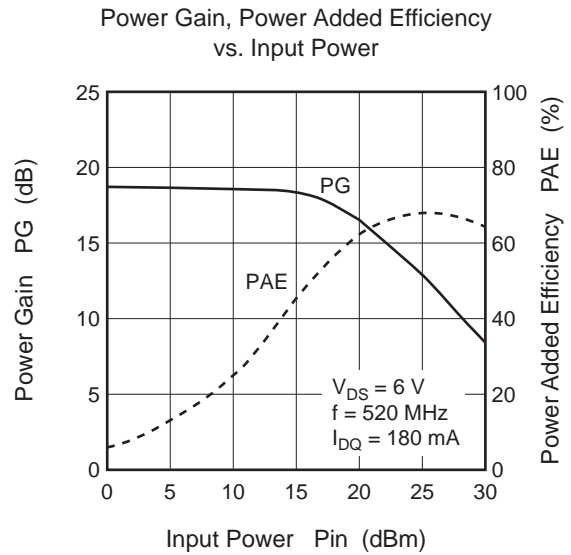
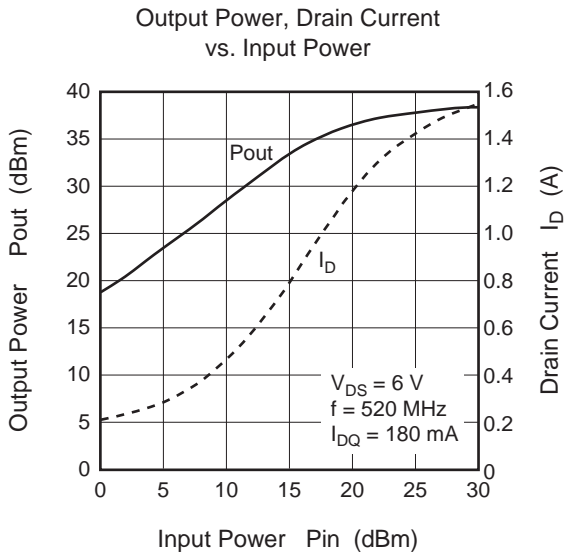

S11 Parameter vs. Frequency

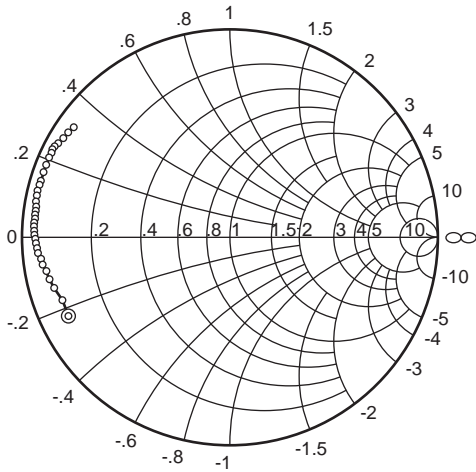

Test condition:

$V_{DS} = 6\text{ V}$, $I_{DQ} = 180\text{ mA}$, $Z_O = 50\ \Omega$
 100 to 1000 MHz (50 MHz step)
 1000 to 2500 MHz (100 MHz step)

S21 Parameter vs. Frequency

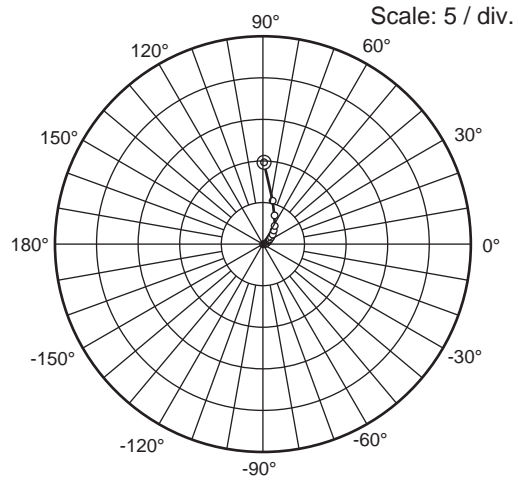

Test condition:

$V_{DS} = 6\text{ V}$, $I_{DQ} = 180\text{ mA}$, $Z_O = 50\ \Omega$
 100 to 1000 MHz (50 MHz step)
 1000 to 2500 MHz (100 MHz step)

S12 Parameter vs. Frequency

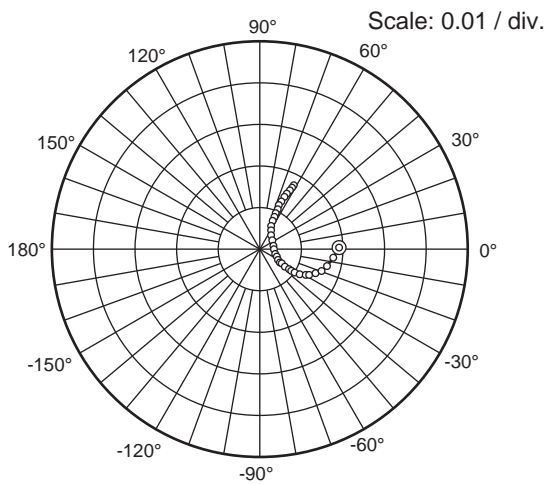

Test condition:

$V_{DS} = 6\text{ V}$, $I_{DQ} = 180\text{ mA}$, $Z_O = 50\ \Omega$
 100 to 1000 MHz (50 MHz step)
 1000 to 2500 MHz (100 MHz step)

S22 Parameter vs. Frequency

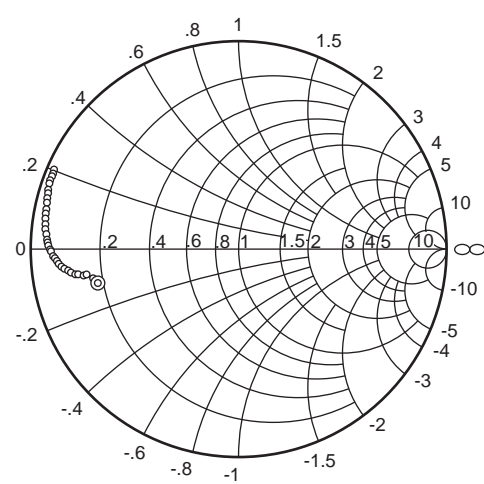

Test condition:

$V_{DS} = 6\text{ V}$, $I_{DQ} = 180\text{ mA}$, $Z_O = 50\ \Omega$
 100 to 1000 MHz (50 MHz step)
 1000 to 2500 MHz (100 MHz step)

S11 Parameter vs. Frequency

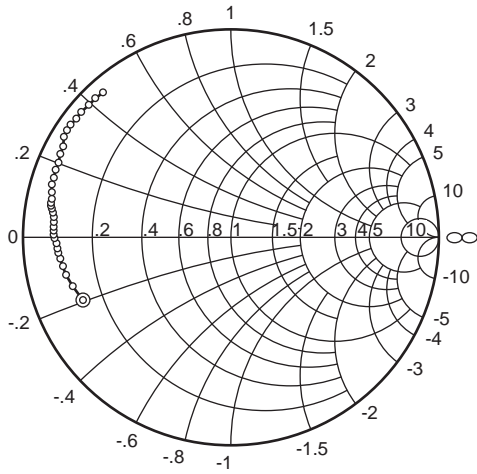

Test condition:

$V_{DS} = 4.8\text{ V}$, $I_{DQ} = 300\text{ mA}$, $Z_O = 50\ \Omega$
 100 to 1000 MHz (50 MHz step)
 1000 to 2500 MHz (100 MHz step)

S21 Parameter vs. Frequency

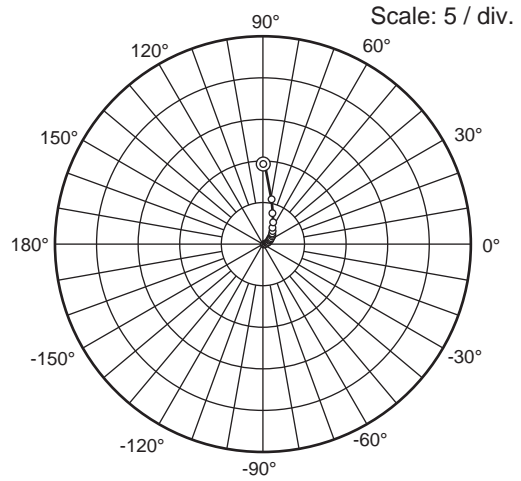

Test condition:

$V_{DS} = 4.8\text{ V}$, $I_{DQ} = 300\text{ mA}$, $Z_O = 50\ \Omega$
 100 to 1000 MHz (50 MHz step)
 1000 to 2500 MHz (100 MHz step)

S12 Parameter vs. Frequency

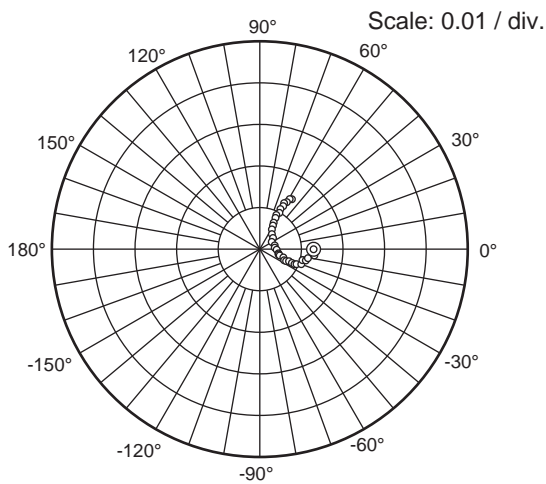

Test condition:

$V_{DS} = 4.8\text{ V}$, $I_{DQ} = 300\text{ mA}$, $Z_O = 50\ \Omega$
 100 to 1000 MHz (50 MHz step)
 1000 to 2500 MHz (100 MHz step)

S22 Parameter vs. Frequency

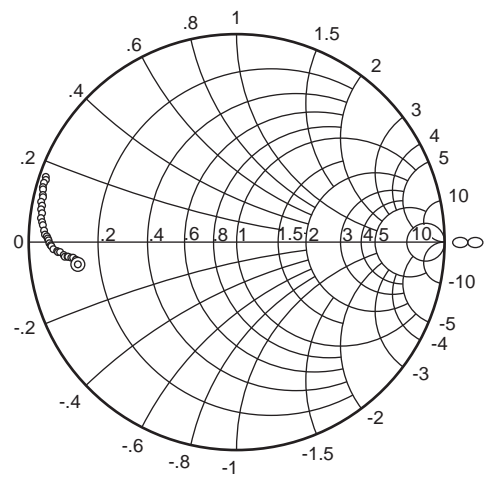

Test condition:

$V_{DS} = 4.8\text{ V}$, $I_{DQ} = 300\text{ mA}$, $Z_O = 50\ \Omega$
 100 to 1000 MHz (50 MHz step)
 1000 to 2500 MHz (100 MHz step)

S Parameter

 $(V_{DS} = 6\text{ V}, I_{DQ} = 180\text{ mA}, Z_o = 50\ \Omega)$

f (MHz)	S11		S21		S12		S22	
	MAG	ANG (deg.)	MAG	ANG (deg.)	MAG	ANG (deg.)	MAG	ANG (deg.)
100	0.868	-154.0	9.85	88.8	0.019	1.2	0.706	-166.8
150	0.861	-159.4	5.42	77.2	0.018	-6.3	0.725	-168.9
200	0.882	-163.9	3.64	68.2	0.016	-14.1	0.755	-170.6
250	0.892	-166.8	2.64	58.5	0.016	-19.2	0.768	-170.6
300	0.899	-169.5	2.06	51.8	0.014	-22.1	0.792	-171.2
350	0.910	-171.6	1.61	45.1	0.013	-27.2	0.805	-171.5
400	0.918	-173.4	1.28	40.3	0.013	-29.3	0.827	-172.2
450	0.926	-175.2	1.04	36.0	0.011	-34.1	0.840	-173.1
500	0.932	-176.8	0.84	31.8	0.010	-33.1	0.855	-173.8
550	0.936	-178.2	0.73	28.8	0.009	-34.5	0.869	-174.6
600	0.940	-179.5	0.62	26.4	0.008	-34.6	0.880	-175.6
650	0.941	179.2	0.54	23.1	0.007	-36.5	0.892	-176.5
700	0.944	178.1	0.45	20.2	0.006	-32.7	0.901	-177.3
750	0.945	176.9	0.41	18.3	0.006	-32.0	0.906	-178.0
800	0.944	175.9	0.37	16.4	0.005	-25.3	0.915	-179.4
850	0.944	174.6	0.31	13.9	0.004	-22.3	0.919	180.0
900	0.943	173.4	0.30	12.1	0.004	-15.2	0.929	178.9
950	0.943	172.3	0.26	10.6	0.003	0.3	0.930	178.1
1000	0.946	171.1	0.23	8.6	0.003	9.1	0.936	177.2
1050	0.949	170.2	0.22	7.3	0.003	20.6	0.940	176.5
1100	0.951	169.4	0.21	6.5	0.004	36.9	0.943	175.5
1150	0.952	168.7	0.18	5.3	0.004	40.3	0.944	174.7
1200	0.952	167.8	0.18	4.3	0.004	52.0	0.950	174.1
1250	0.952	167.0	0.16	3.7	0.005	53.2	0.951	173.3
1300	0.952	166.2	0.14	2.2	0.005	56.8	0.949	172.6
1350	0.952	165.4	0.14	1.3	0.006	60.9	0.956	171.7
1400	0.952	164.6	0.13	0.8	0.006	64.0	0.958	171.0
1450	0.952	164.0	0.12	0.1	0.007	62.2	0.957	170.3
1500	0.952	163.3	0.11	-0.8	0.008	65.4	0.956	169.5
1550	0.952	162.1	0.11	-1.8	0.008	65.9	0.959	168.5
1600	0.952	160.8	0.10	-2.7	0.009	65.6	0.960	168.2
1650	0.952	159.7	0.10	-3.6	0.009	65.9	0.960	167.4
1700	0.952	158.5	0.09	-4.5	0.010	66.6	0.962	166.4
1750	0.952	157.3	0.08	-4.7	0.010	66.2	0.967	165.8
1800	0.952	156.4	0.08	-5.0	0.011	66.5	0.968	165.3
1850	0.952	155.7	0.08	-4.7	0.011	66.5	0.965	164.5
1900	0.953	154.7	0.07	-4.9	0.012	67.0	0.967	163.7
1950	0.958	153.9	0.07	-5.2	0.012	67.0	0.976	163.2
2000	0.965	153.6	0.07	-4.6	0.013	65.5	0.972	162.9
2050	0.963	153.3	0.07	-4.9	0.013	65.4	0.972	161.9
2100	0.956	152.9	0.06	-4.2	0.014	65.3	0.976	161.0
2150	0.950	152.2	0.06	-3.5	0.014	65.2	0.981	160.7
2200	0.944	151.6	0.06	-3.8	0.015	63.9	0.977	160.1
2250	0.936	150.7	0.06	-3.5	0.015	63.9	0.977	159.5
2300	0.932	149.3	0.05	-3.4	0.016	63.0	0.978	158.9
2350	0.932	148.1	0.05	-3.6	0.016	62.8	0.981	158.4
2400	0.929	147.3	0.05	-3.0	0.017	63.0	0.977	158.0
2450	0.923	146.3	0.05	-3.6	0.017	61.3	0.977	157.2
2500	0.917	144.9	0.05	-3.0	0.017	61.8	0.980	156.8

S Parameter

 $(V_{DS} = 4.8 \text{ V}, I_{DQ} = 300 \text{ mA}, Z_o = 50 \Omega)$

f (MHz)	S11		S21		S12		S22	
	MAG	ANG (deg.)	MAG	ANG (deg.)	MAG	ANG (deg.)	MAG	ANG (deg.)
100	0.772	-157.0	9.63	88.9	0.013	-1.0	0.776	-172.1
150	0.794	-162.8	5.54	79.0	0.013	-6.3	0.784	-173.8
200	0.812	-167.3	3.91	71.6	0.012	-11.1	0.799	-174.8
250	0.818	-170.4	2.98	64.7	0.011	-13.5	0.805	-174.8
300	0.824	-173.1	2.36	59.1	0.011	-15.2	0.818	-175.0
350	0.831	-175.0	1.92	53.6	0.011	-20.4	0.824	-175.1
400	0.836	-176.6	1.60	48.7	0.010	-21.4	0.837	-175.4
450	0.841	-178.3	1.36	44.8	0.009	-23.3	0.843	-175.8
500	0.848	-179.9	1.15	40.5	0.008	-22.9	0.859	-176.8
550	0.851	179.0	1.00	37.1	0.008	-22.2	0.868	-177.1
600	0.851	177.7	0.87	33.9	0.007	-24.8	0.874	-177.4
650	0.852	176.3	0.77	30.7	0.006	-24.2	0.887	-177.8
700	0.854	174.7	0.69	27.9	0.006	-20.5	0.896	-178.8
750	0.858	173.3	0.60	24.8	0.005	-18.2	0.901	-179.1
800	0.865	171.9	0.54	22.3	0.005	-15.1	0.905	-179.8
850	0.873	170.8	0.49	20.2	0.005	-12.2	0.911	179.5
900	0.878	169.8	0.45	17.9	0.004	-1.7	0.918	178.9
950	0.880	168.8	0.41	16.1	0.004	4.3	0.922	178.3
1000	0.882	167.7	0.37	14.2	0.004	11.2	0.932	177.8
1050	0.886	166.5	0.35	12.4	0.004	21.6	0.931	177.1
1100	0.889	165.5	0.32	10.7	0.004	29.8	0.935	176.5
1150	0.893	164.4	0.29	8.9	0.004	33.2	0.939	175.8
1200	0.898	163.3	0.27	7.5	0.004	40.9	0.944	175.1
1250	0.902	162.4	0.26	6.2	0.005	46.7	0.943	174.6
1300	0.901	161.3	0.23	4.7	0.005	50.8	0.948	174.1
1350	0.902	160.0	0.22	3.3	0.005	54.5	0.948	173.4
1400	0.904	158.7	0.21	1.8	0.006	57.8	0.954	173.1
1450	0.907	157.7	0.19	0.4	0.006	55.3	0.954	172.5
1500	0.904	156.5	0.18	-0.8	0.007	60.5	0.953	171.6
1550	0.905	155.1	0.17	-2.4	0.007	62.1	0.958	171.0
1600	0.912	153.8	0.16	-3.1	0.007	61.1	0.959	170.7
1650	0.915	152.8	0.15	-4.2	0.008	64.3	0.956	170.4
1700	0.919	151.5	0.14	-5.8	0.008	63.2	0.958	169.3
1750	0.926	149.9	0.14	-6.8	0.009	62.7	0.964	168.9
1800	0.938	148.8	0.13	-7.8	0.009	63.0	0.965	168.4
1850	0.942	147.9	0.13	-8.6	0.010	62.6	0.963	167.8
1900	0.942	146.7	0.12	-9.3	0.010	61.9	0.965	167.0
1950	0.945	145.5	0.11	-10.2	0.010	63.8	0.968	166.6
2000	0.946	144.7	0.11	-10.6	0.011	62.4	0.965	166.3
2050	0.942	143.7	0.11	-11.2	0.011	62.2	0.969	165.5
2100	0.939	142.3	0.10	-11.8	0.012	61.2	0.973	164.9
2150	0.940	140.9	0.10	-12.5	0.012	62.0	0.974	164.6
2200	0.942	139.8	0.09	-13.3	0.012	61.3	0.974	164.2
2250	0.939	138.3	0.09	-14.3	0.013	59.2	0.974	163.4
2300	0.937	136.8	0.08	-15.3	0.013	59.6	0.976	163.0
2350	0.937	135.4	0.08	-16.3	0.014	59.8	0.977	162.9
2400	0.935	134.1	0.08	-17.5	0.014	58.9	0.972	162.0
2450	0.932	132.8	0.07	-18.1	0.014	57.9	0.975	161.5
2500	0.931	131.3	0.07	-18.7	0.014	57.7	0.977	161.2

Package Dimensions

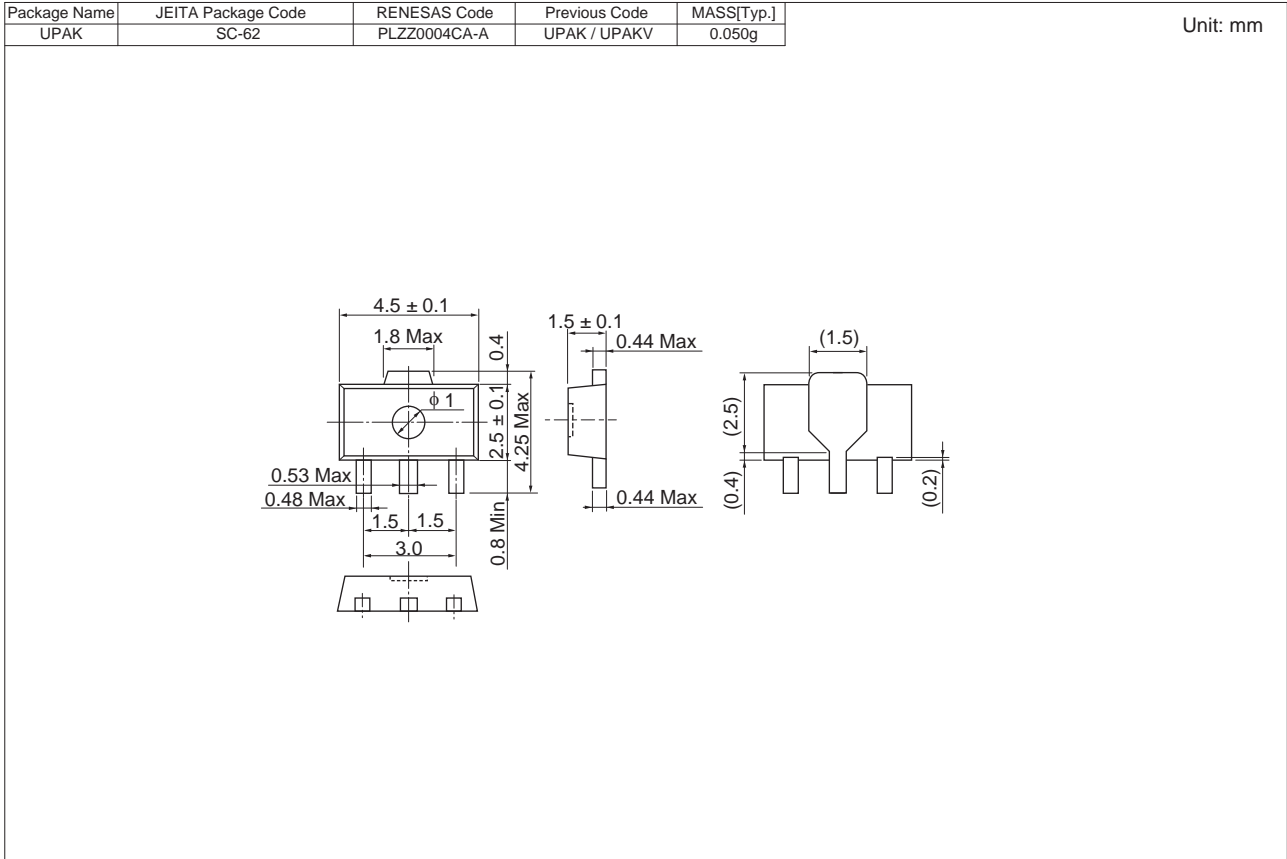

Ordering Information

Orderable Part Number	Quantity	Shipping Container
RQA0009SXTL-E	1000 pcs.	$\phi 178$ mm reel, 12 mm emboss taping

Notice

- All information included in this document is current as of the date this document is issued. Such information, however, is subject to change without any prior notice. Before purchasing or using any Renesas Electronics products listed herein, please confirm the latest product information with a Renesas Electronics sales office. Also, please pay regular and careful attention to additional and different information to be disclosed by Renesas Electronics such as that disclosed through our website.
- Renesas Electronics does not assume any liability for infringement of patents, copyrights, or other intellectual property rights of third parties by or arising from the use of Renesas Electronics products or technical information described in this document. No license, express, implied or otherwise, is granted hereby under any patents, copyrights or other intellectual property rights of Renesas Electronics or others.
- You should not alter, modify, copy, or otherwise misappropriate any Renesas Electronics product, whether in whole or in part.
- Descriptions of circuits, software and other related information in this document are provided only to illustrate the operation of semiconductor products and application examples. You are fully responsible for the incorporation of these circuits, software, and information in the design of your equipment. Renesas Electronics assumes no responsibility for any losses incurred by you or third parties arising from the use of these circuits, software, or information.
- When exporting the products or technology described in this document, you should comply with the applicable export control laws and regulations and follow the procedures required by such laws and regulations. You should not use Renesas Electronics products or the technology described in this document for any purpose relating to military applications or use by the military, including but not limited to the development of weapons of mass destruction. Renesas Electronics products and technology may not be used for or incorporated into any products or systems whose manufacture, use, or sale is prohibited under any applicable domestic or foreign laws or regulations.
- Renesas Electronics has used reasonable care in preparing the information included in this document, but Renesas Electronics does not warrant that such information is error free. Renesas Electronics assumes no liability whatsoever for any damages incurred by you resulting from errors in or omissions from the information included herein.
- Renesas Electronics products are classified according to the following three quality grades: "Standard", "High Quality", and "Specific". The recommended applications for each Renesas Electronics product depends on the product's quality grade, as indicated below. You must check the quality grade of each Renesas Electronics product before using it in a particular application. You may not use any Renesas Electronics product for any application categorized as "Specific" without the prior written consent of Renesas Electronics. Further, you may not use any Renesas Electronics product for any application for which it is not intended without the prior written consent of Renesas Electronics. Renesas Electronics shall not be in any way liable for any damages or losses incurred by you or third parties arising from the use of any Renesas Electronics product for an application categorized as "Specific" or for which the product is not intended where you have failed to obtain the prior written consent of Renesas Electronics. The quality grade of each Renesas Electronics product is "Standard" unless otherwise expressly specified in a Renesas Electronics data sheets or data books, etc.
"Standard": Computers; office equipment; communications equipment; test and measurement equipment; audio and visual equipment; home electronic appliances; machine tools; personal electronic equipment; and industrial robots.
"High Quality": Transportation equipment (automobiles, trains, ships, etc.); traffic control systems; anti-disaster systems; anti-crime systems; safety equipment; and medical equipment not specifically designed for life support.
"Specific": Aircraft; aerospace equipment; submersible repeaters; nuclear reactor control systems; medical equipment or systems for life support (e.g. artificial life support devices or systems), surgical implantations, or healthcare intervention (e.g. excision, etc.), and any other applications or purposes that pose a direct threat to human life.
- You should use the Renesas Electronics products described in this document within the range specified by Renesas Electronics, especially with respect to the maximum rating, operating supply voltage range, movement power voltage range, heat radiation characteristics, installation and other product characteristics. Renesas Electronics shall have no liability for malfunctions or damages arising out of the use of Renesas Electronics products beyond such specified ranges.
- Although Renesas Electronics endeavors to improve the quality and reliability of its products, semiconductor products have specific characteristics such as the occurrence of failure at a certain rate and malfunctions under certain use conditions. Further, Renesas Electronics products are not subject to radiation resistance design. Please be sure to implement safety measures to guard them against the possibility of physical injury, and injury or damage caused by fire in the event of the failure of a Renesas Electronics product, such as safety design for hardware and software including but not limited to redundancy, fire control and malfunction prevention, appropriate treatment for aging degradation or any other appropriate measures. Because the evaluation of microcomputer software alone is very difficult, please evaluate the safety of the final products or system manufactured by you.
- Please contact a Renesas Electronics sales office for details as to environmental matters such as the environmental compatibility of each Renesas Electronics product. Please use Renesas Electronics products in compliance with all applicable laws and regulations that regulate the inclusion or use of controlled substances, including without limitation, the EU RoHS Directive. Renesas Electronics assumes no liability for damages or losses occurring as a result of your noncompliance with applicable laws and regulations.
- This document may not be reproduced or duplicated, in any form, in whole or in part, without prior written consent of Renesas Electronics.
- Please contact a Renesas Electronics sales office if you have any questions regarding the information contained in this document or Renesas Electronics products, or if you have any other inquiries.
(Note 1) "Renesas Electronics" as used in this document means Renesas Electronics Corporation and also includes its majority-owned subsidiaries.
(Note 2) "Renesas Electronics product(s)" means any product developed or manufactured by or for Renesas Electronics.



SALES OFFICES

Renesas Electronics Corporation

<http://www.renesas.com>

Refer to "<http://www.renesas.com/>" for the latest and detailed information.

Renesas Electronics America Inc.
2880 Scott Boulevard Santa Clara, CA 95050-2554, U.S.A.
Tel: +1-408-588-6000, Fax: +1-408-588-6130

Renesas Electronics Canada Limited
1101 Nicholson Road, Newmarket, Ontario L3Y 9C3, Canada
Tel: +1-905-898-5441, Fax: +1-905-898-3220

Renesas Electronics Europe Limited
Dukes Meadow, Millboard Road, Bourne End, Buckinghamshire, SL8 5FH, U.K.
Tel: +44-1628-585-100, Fax: +44-1628-585-900

Renesas Electronics Europe GmbH
Arcadiastrasse 10, 40472 Düsseldorf, Germany
Tel: +49-211-65030, Fax: +49-211-6503-1327

Renesas Electronics (China) Co., Ltd.
7th Floor, Quantum Plaza, No.27 ZhiChunLu Haidian District, Beijing 100083, P.R.China
Tel: +86-10-8235-1155, Fax: +86-10-8235-7679

Renesas Electronics (Shanghai) Co., Ltd.
Unit 204, 205, AZIA Center, No.1233 Lujiazui Ring Rd., Pudong District, Shanghai 200120, China
Tel: +86-21-5877-1818, Fax: +86-21-6887-7858 / -7898

Renesas Electronics Hong Kong Limited
Unit 1601-1613, 16/F., Tower 2, Grand Century Place, 193 Prince Edward Road West, Mongkok, Kowloon, Hong Kong
Tel: +852-2886-9318, Fax: +852 2886-9022/9044

Renesas Electronics Taiwan Co., Ltd.
13F, No. 363, Fu Shing North Road, Taipei, Taiwan
Tel: +886-2-8175-9600, Fax: +886 2-8175-9670

Renesas Electronics Singapore Pte. Ltd.
1 HarbourFront Avenue, #06-10, Keppel Bay Tower, Singapore 098632
Tel: +65-6213-0200, Fax: +65-6278-8001

Renesas Electronics Malaysia Sdn.Bhd.
Unit 906, Block B, Menara Amcorp, Amcorp Trade Centre, No. 18, Jin Persiaran Barat, 46050 Petaling Jaya, Selangor Darul Ehsan, Malaysia
Tel: +60-3-7955-9390, Fax: +60-3-7955-9510

Renesas Electronics Korea Co., Ltd.
11F., Samik Lavied' or Bldg., 720-2 Yeoksam-Dong, Kangnam-Ku, Seoul 135-080, Korea
Tel: +82-2-558-3737, Fax: +82-2-558-5141